

VERVE PRO 8

DESIGNED FOR *EVERYDAY LUXURY.*

flair
PRO



SIDE PANEL

FITTING INSTRUCTIONS

GUARANTEE & AFTERSALES SERVICE

QUALITY GUARANTEED

At Flair we have an unwavering commitment to product quality.

Verve shower doors are covered by a 20 year guarantee against manufacturer defect. This guarantee is valid on the condition that goods are installed and maintained in accordance with the products fitting instructions and best practices.

Non glass and detachable parts such as rollers, seals etc. are subject to normal wear and tear during usage and are under guarantee for 12 months from time of purchase.

Please complete your product guarantee card included in the components box or register online at flairshowers.com/register.

All Flair products are CE/UKCA approved. All glass is toughened safety glass and produced to EN12150. Flair products are performance tested to EN14428, ensuring the highest industry criteria is met.

AFTERSALES & SPARE PARTS SERVICE

Flair is 100% committed to customer service excellence.

We carry a full range of spare parts for each of our product ranges and have dedicated aftersales representatives to deal with any issues you may have.

If you would like to talk to our customer aftercare team, please contact us on 042 966 8000.



WARNING!

BEFORE YOU INSTALL YOUR SHOWER ENCLOSURE PLEASE READ ALL INSTRUCTIONS. FAILURE TO DO SO MAY LEAD TO INVALIDATION OF YOUR WARRANTY.

The shower tray **MUST** be fitted 100% level.

Glass door edges are vulnerable. Contact with hard surfaces may result in glass breakage.

The shower enclosure should be sealed only on the outside using silicone sealant.

Check walls for electrical cabling or water pipes before drilling.

Your shower enclosure must be inspected 100% before installation. Once the enclosure has been installed no claims of damage or defect will be accepted. Fitting of shower enclosure is acceptance of quality.

The wall plugs supplied with for installation are for use in solid walls. Timber frame, stud partition walls will require alternative fixings.





Shower Tray must be installed 100% level in all directions and sealed at the wall with silicone; especially under the profiles of the shower enclosure.

Flair Showers Ltd will not accept responsibility for any loss or damage, however caused, if the shower enclosure has not been installed as per the instructions.

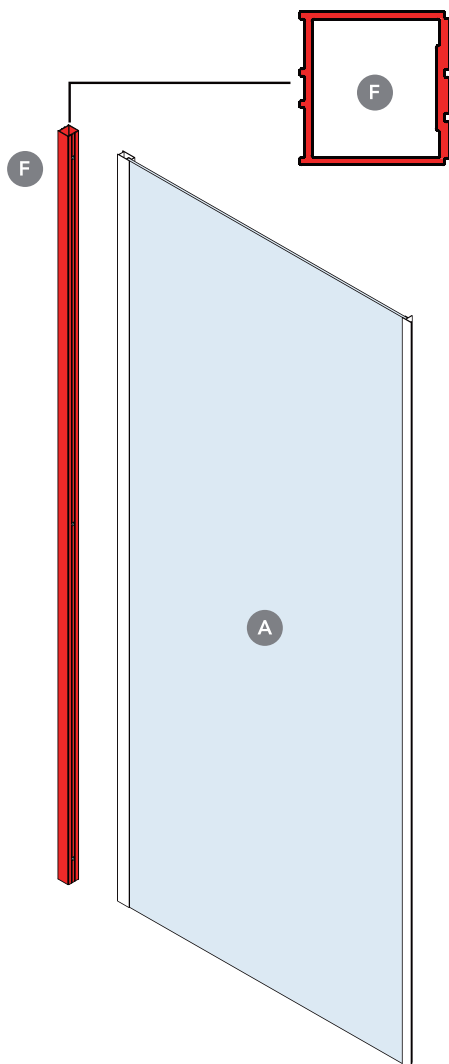
IN THE BOX

TAKE A MINUTE TO CHECK THE
CONTENTS OF EACH BOX

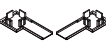

ITEM		QUANTITY
B	 4x10	4 Pc
D		4 Pc
E		1 + 1 Pc
G	 4x12	3 Pc
H		1 + 1 Pc

1

VERVE PRO 8

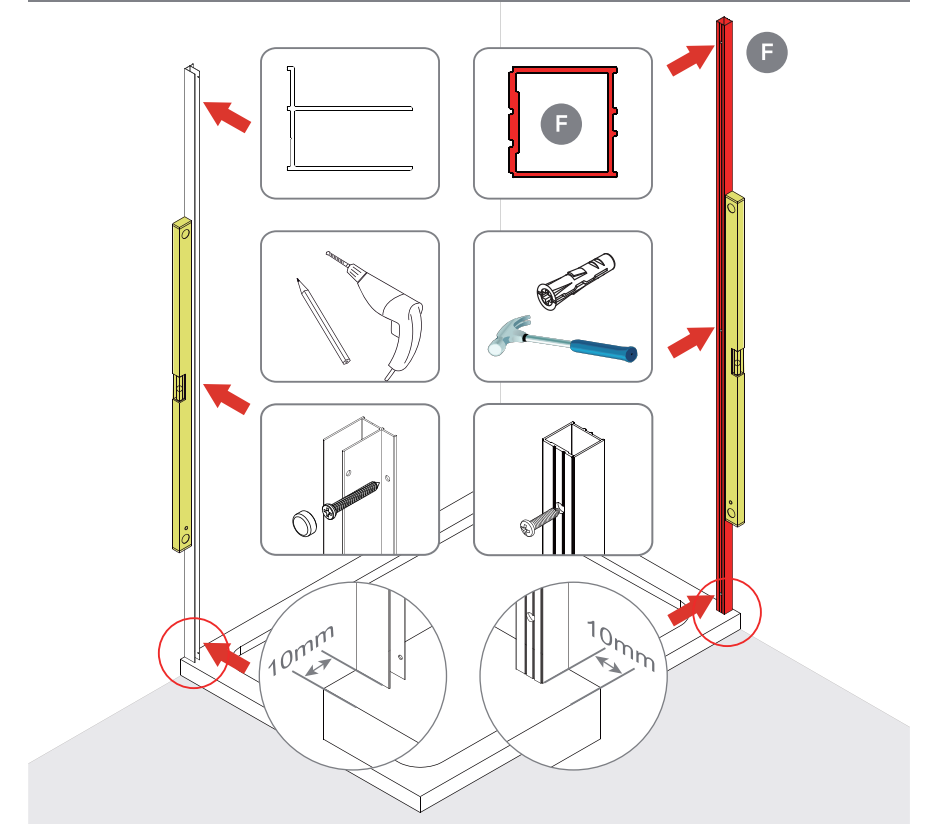
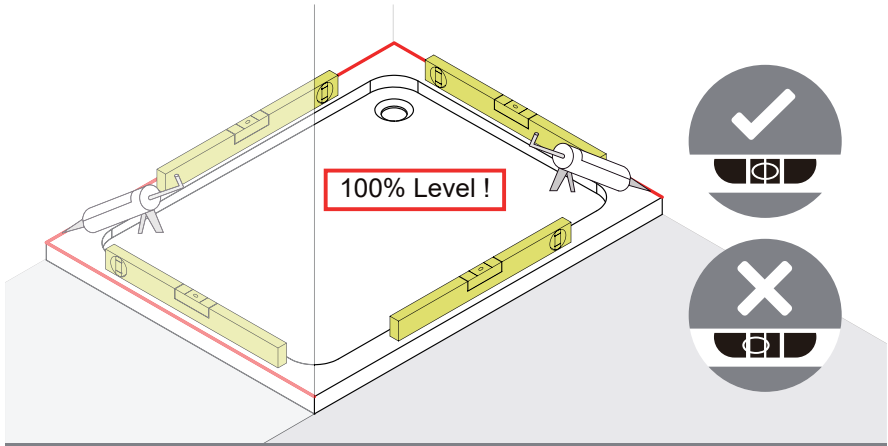

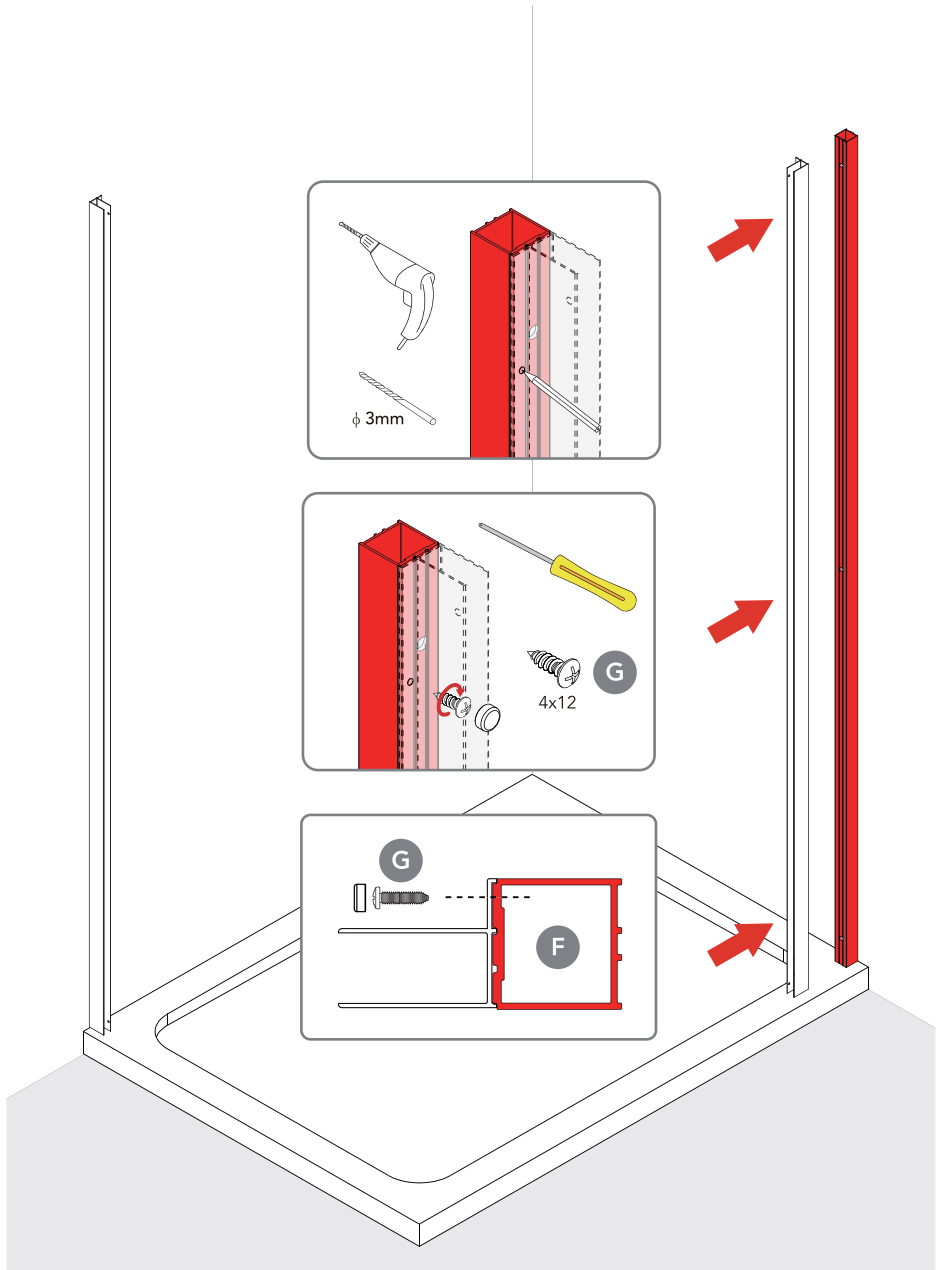

3

VERVE PRO 8

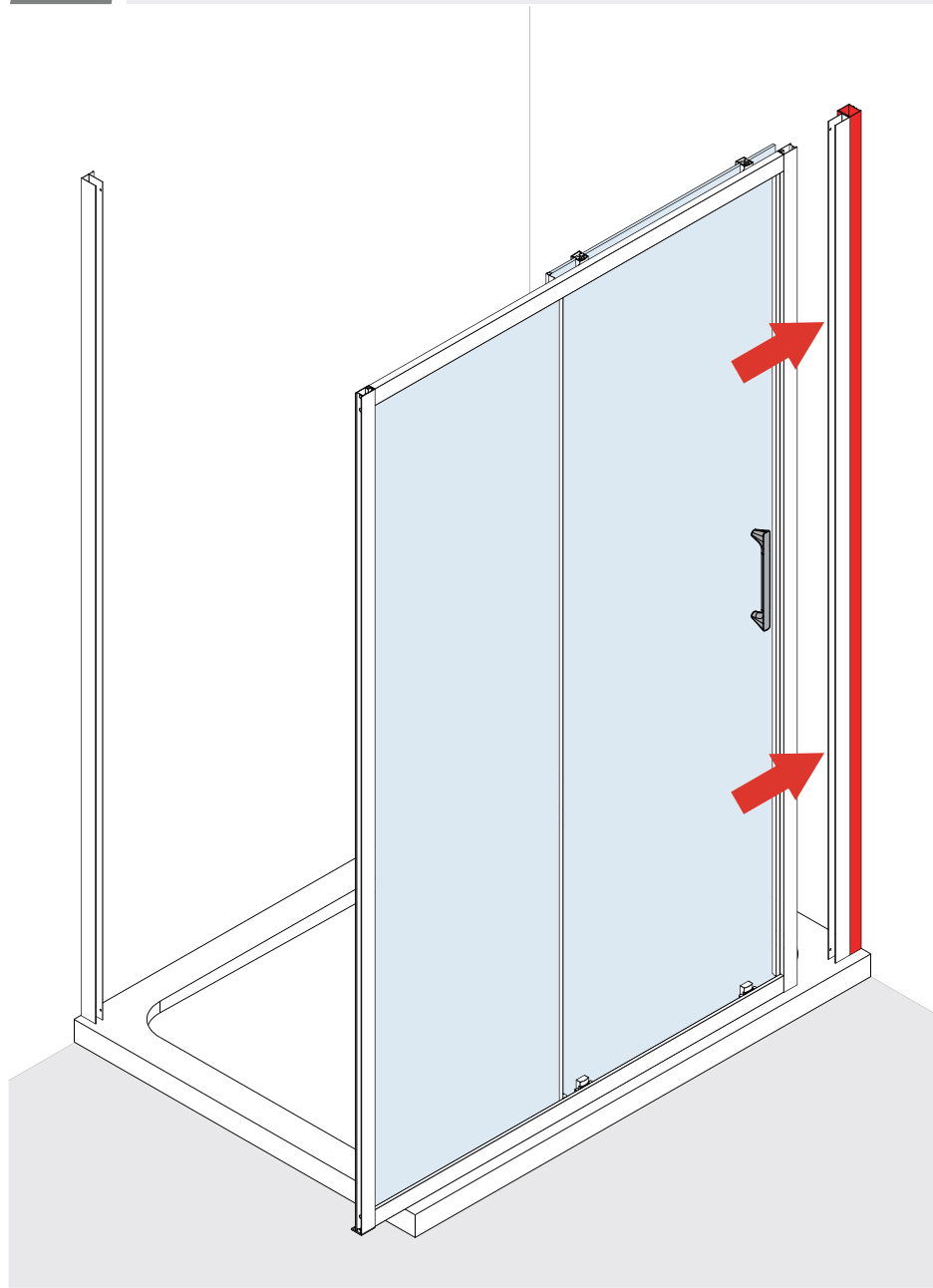

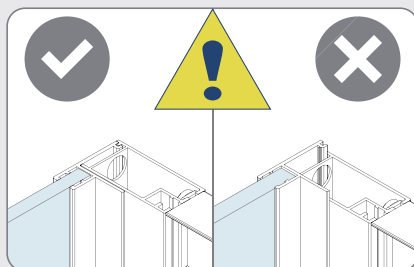
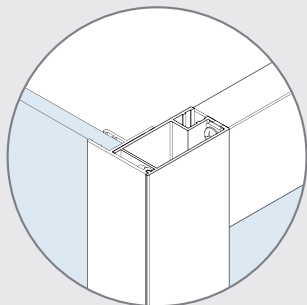
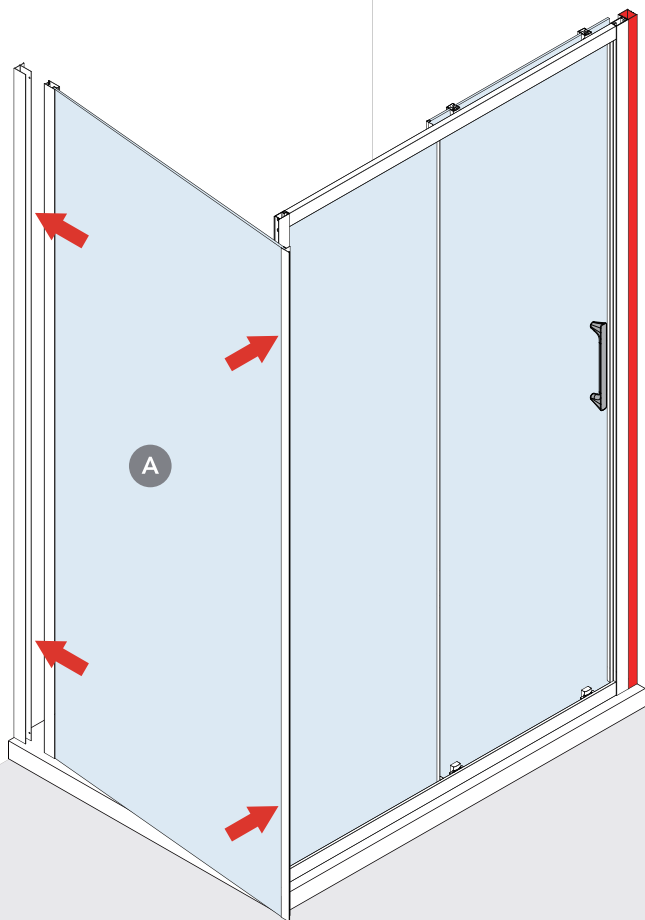

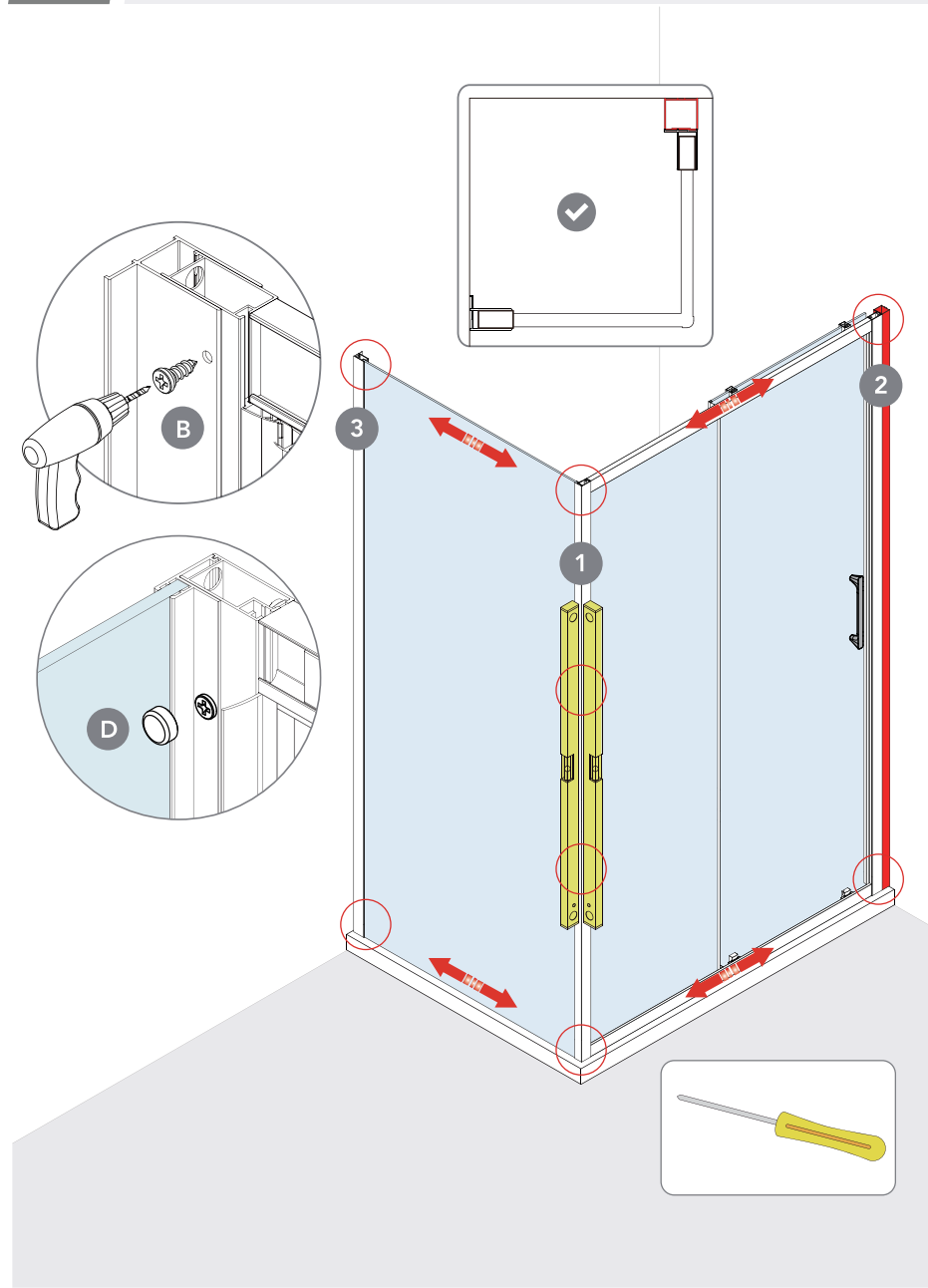

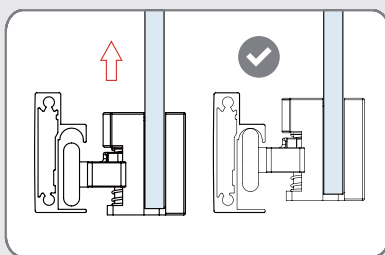
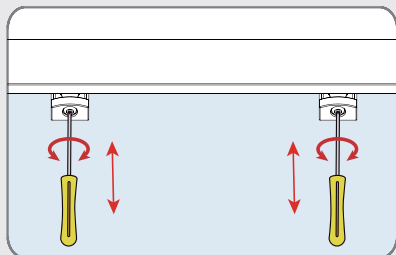
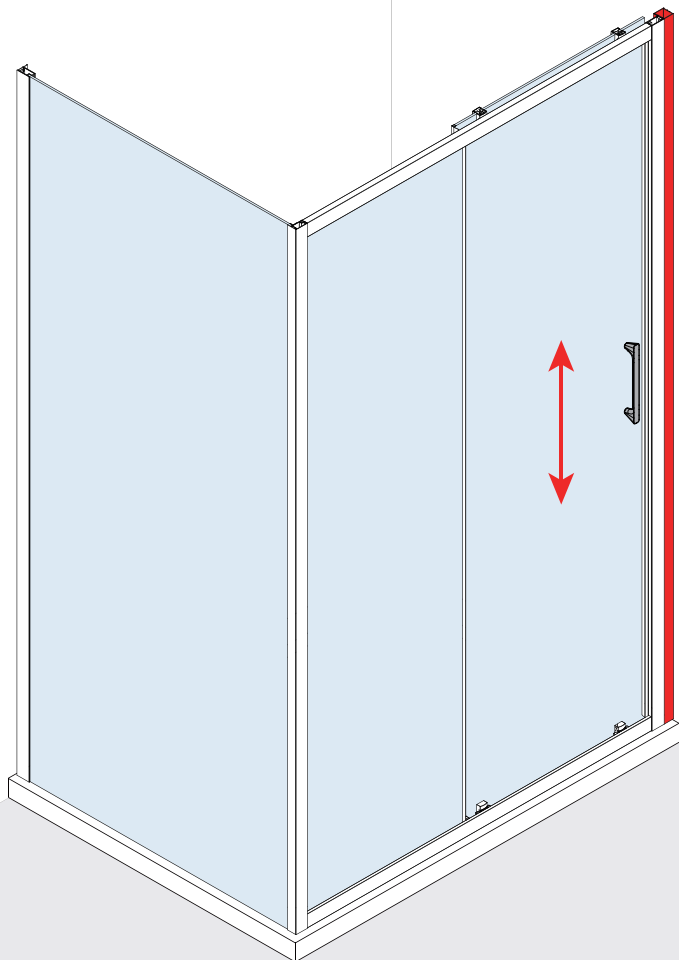

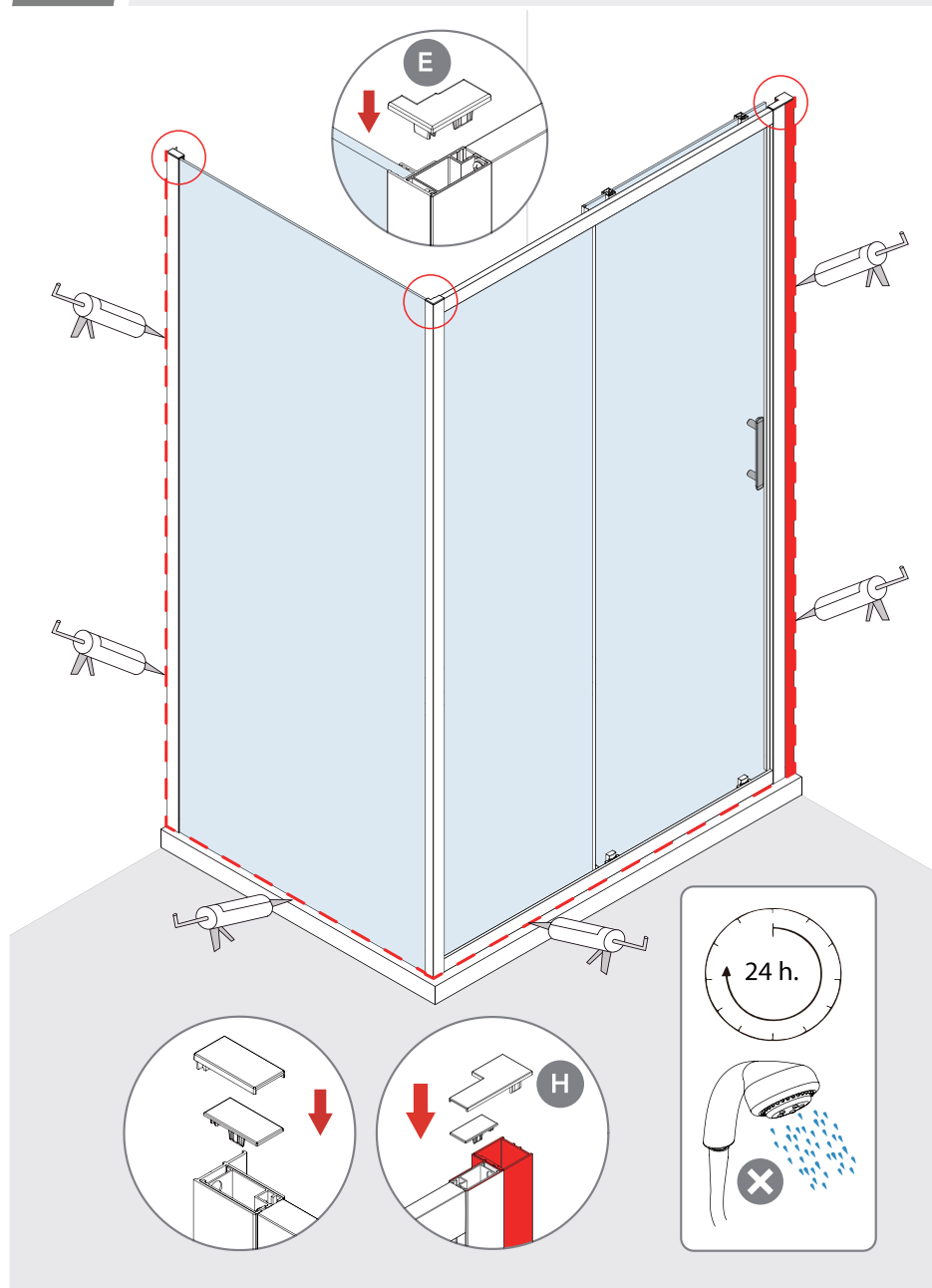

INSTALLATION & MAINTENANCE

INSTALLATION TIPS

It is the responsibility of the installer to ensure that the product is installed correctly and due care is given to the instructions.

Your guarantee is invalid if the instructions have not been followed correctly.

- Please check for all visual defects on the product before installation - such defects will not be accepted after installation of the product
- For shower enclosures a spirit level should be used to ensure your shower tray is level - if the shower tray is not level your shower door will not fit
- Ensure vertical wall profiles are level and are an equal distance in from the tray
- Ensure adjustment at wall profiles are equal at both side and that all screws are fully tightened
- Ensure hinges are level and securely fitted to the glass
- Ensure magnets are the right orientation are attracting rather than repelling
- Ensure silicone is used to waterproof your shower enclosure
- Care must be taken during assembly. Flair will not take responsibility where incorrect assembly results in undue stress being put on any of the glass components in this product
- If there are any manufacturing problems please call Flair Service Line on +353 42 966 8000
Note: If the problem has been caused by poor installation, there will be an initial call-out charge for our technical engineer and subsequent charges to the end user "to fix" a problem caused by poor installation.

CLEANING

Clean glass coating is a standard feature on all Verve shower doors. This easy to clean glass coating is applied to the glass surface and ensures that soap deposits and lime scale are easily cleaned off the glass.

Glass: Use a soft cloth and mild detergent, rinse off thoroughly
Metallic Surfaces: Use a soft cloth and warm soapy water*
Painted Surfaces: Use a soft cloth & mild detergent, rinse off thoroughly*

*Do not use "Spray & leave" cleaning products on the metal surface as these will cause damage to your shower door. These include acidic based cleaning products, bleaches, solvents or abrasive pads. These will damage the anodising layer on the aluminium profiles.

*In hard water areas, regular cleaning of your Flair door will help to prevent the buildup of limescale. Stubborn deposits of limescale can be removed with the use of a mild limescale remover.

*Only use detergents, cleaners and limescale removers with a pH of 5-8.

*The constant use of detergents will degrade the finish of the product over time if not thoroughly rinsed off.

MAINTENANCE TIPS

- Check your shower door for functionality periodically
- Ensure that the wheel track is free from any grit/dirt which may have collected over time
- Lubricate the wheel systems and track using a suitable fine lubricant spray or grease every 6 months.
- Only use non-abrasive cleaning agents on all Flair products and rinse off thoroughly.
- Do not use excessive force when opening and closing your shower door as this could result in shattering
- Do not hang from your shower door or shower door handle - it is not designed to support excessive weight.

VERVE PRO 8

DESIGNED FOR *EVERYDAY LUXURY.*

Flair Showers Ltd.
Rocks Road
Kingscourt
Co Cavan
Ireland

T : +353 42 966 8000

E : sales@flairshowers.com