TRUST FLAIR
TRUST PRO

THE **ULTIMATE** EASY FIT SHOWERING SOLUTIONS

UK - APRIL 2025



ESSENTIAL COLLECTIONS
TECHNICAL

FLAIRSHOWERS.COM

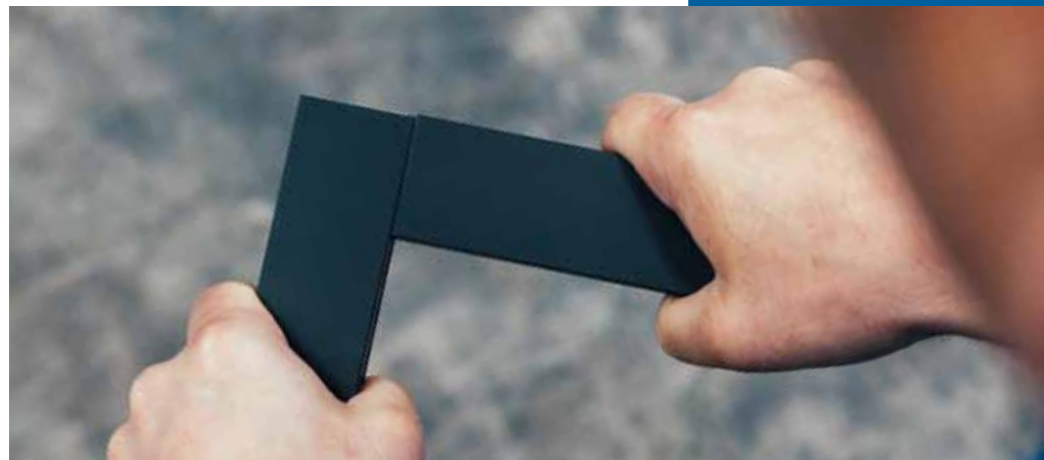

**HAVE YOU
CLICKED YET?**



EXCEPTIONAL EVERYDAY.

Flair has been designing showering solutions for over 70 years and perfecting them since. Our products are beautifully designed and expertly engineered to stand the test of time in the busiest of bathrooms. At Flair our vision is to produce beautifully designed, expertly crafted showering solutions for every customer, every budget, style & space.

The tradition of design excellence continues with the launch of our Flair PRO Essential Collections; an extensive portfolio of shower enclosures, wetrooms, and bathscreens that are tailored to meet the exacting demands of trade professionals.

Flair PRO Essential Collections are engineered for quick installation without having to compromise on quality, look and feel. We are trusted for our commitment to delivering innovative solutions that make your job quicker and easier.

All backed by Flair's 20 year guarantee.



TRUST FLAIR
TRUST PRO





THE ULTIMATE EASY FIT SHOWERING SOLUTIONS

■ *Easy to fit*

Flair's professional grade showering solutions have been developed to be quick and easy to fit. Our innovative installation designs mean that frames can be quickly put into place. We also provide user-friendly instructions and generous adjustments.

■ *Built to last*

We invest in product design, materials and quality control to make sure our products stand the test of time and provide a true fit-and-forget solution.

■ *Unrivalled choice*

Our showering collections have something for every customer, every budget, style and space.

■ *Exceptional customer support*

The success of Flair has been built upon exceptional service and support. From advising on product selection to quickly finding spare parts, our friendly team are here to help.



Scan the code to visit our YouTube channel and view the Installation Videos

CONTENTS

VERVE PRO 8	12
VERVE PRO	22
VERVE WETROOMS	40
VERVE BATHSCREENS	44
SLIMLINE TELESCOPIC	52
FRAMELESS SIX	60
SHOWER TRAYS	70
SPECIFICATION COMPARISON	84

EXCEPTIONAL
EVERYDAY.

flair
—
PRO

FIND YOUR FLAIR.



8mm
TOUGHENED SAFETY GLASS

6mm
TOUGHENED SAFETY GLASS

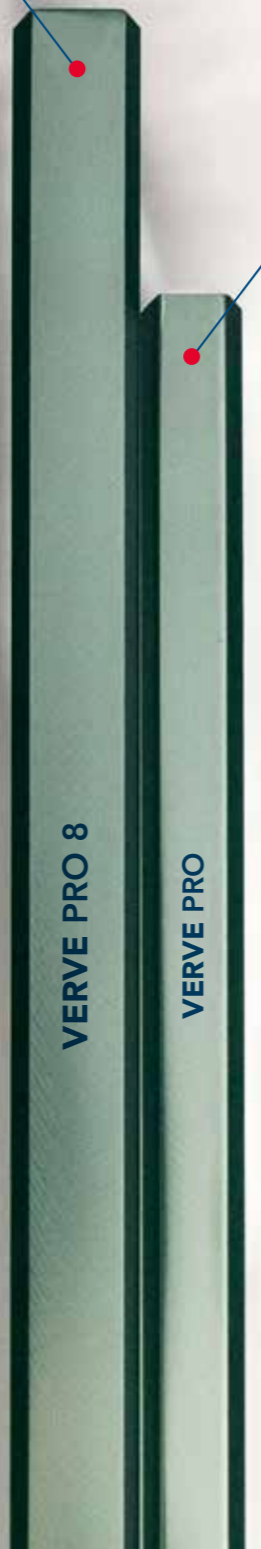

THE DIFFERENCE IS CLEAR!

VERVE PRO

THE ULTIMATE EASY FIT SHOWERING SOLUTIONS AVAILABLE IN 8MM & 6MM TOUGHENED SAFETY GLASS

Our Verve shower enclosures feature a Click Fit PRO assembly system that is expertly engineered to simplify life for trade professionals. Designed for fast, secure, and hassle-free setup, it provides the ultimate solution for quick, easy, and reliable installations.

Combining practicality with quality and professional aesthetics, the Verve Click Fit PRO system reflects Flair Showers' dedication to delivering seamless performance for both trade professionals and homeowners alike.



UP TO
8mm
TOUGHENED SAFETY GLASS

VERVE PRO 8

Designed for everyday luxury, the Verve PRO 8 boasts up to 8mm robust glass, quick installation, and a choice of Silver, Matte Black, or Brushed Brass finishes.

- SILVER
- MATTE BLACK
- BRUSHED BRASS

6mm
TOUGHENED SAFETY GLASS

VERVE PRO

Trusted for everyday bathrooms, the Verve PRO features durable 6mm glass and the Click Fit PRO system, offering effortless style in Silver and Matte Black.

- SILVER
- MATTE BLACK

CLICK FIT PRO

Step 1

Align the horizontal profile and vertical shower door profiles together so they are in a straight upward position.



flair
PRO
The Hallmark
of Innovation



Step 2

Slide the pre-assembled click-fit PRO bracket into place on the vertical profile so the snap hook smoothly locks into the snap fit access port, connecting the two profiles and forming a secure screw-free joint.



Engineered for
VERVE PRO 8 + VERVE PRO
(where applicable)

SCREW-FREE ASSEMBLY SYSTEM FOR QUICK & EASY INSTALLATION.

INSTALLERS
CHOICE

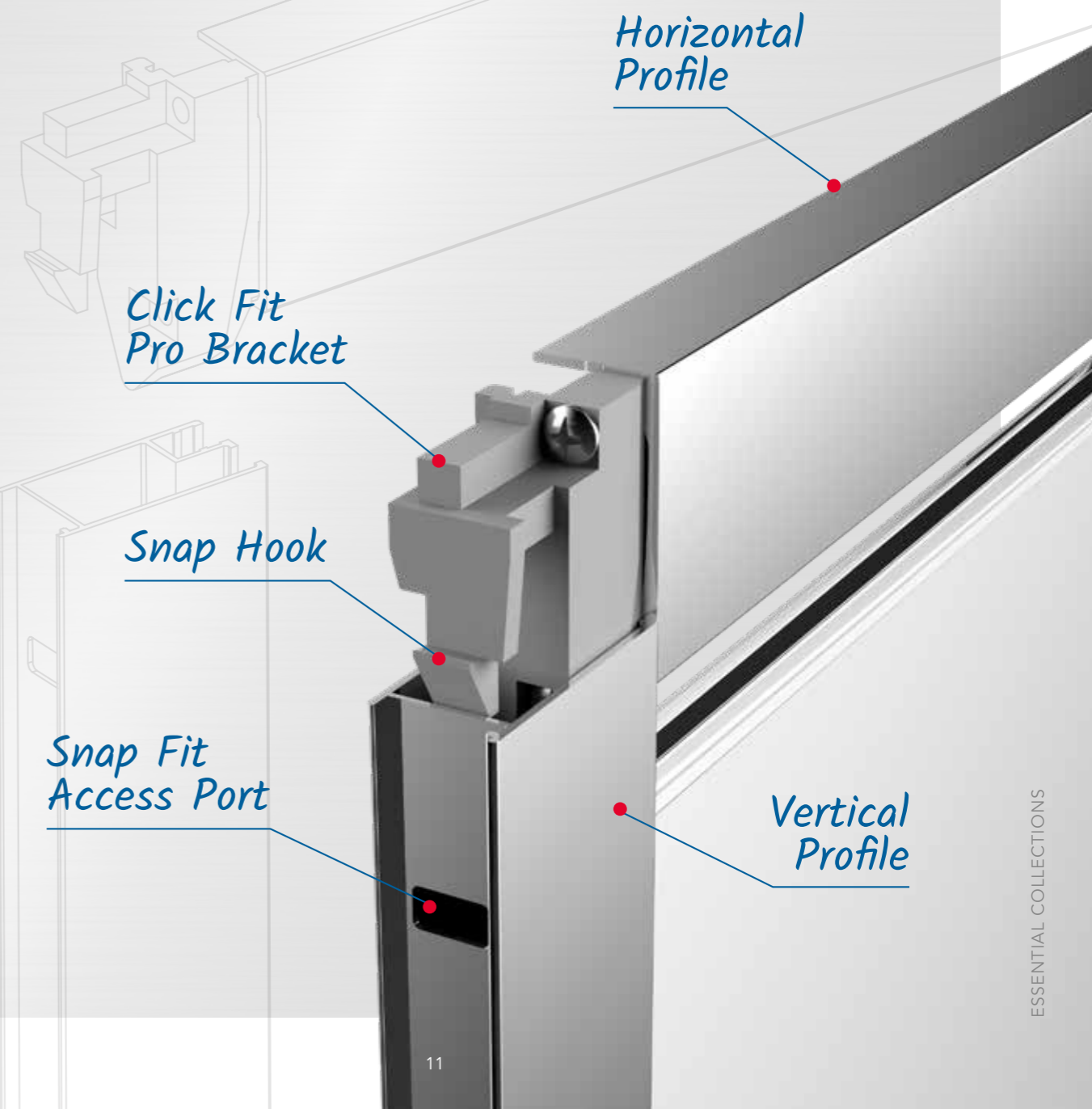

DESIGNED FOR
EVERYDAY LUXURY.



INTRODUCING

VERVE PRO 8

Introducing Verve PRO 8 – a collection designed to elevate your daily showering ritual with a touch of luxury.

Crafted with up to 8mm toughened glass, it blends strength with a sleek, professional aesthetic.

Engineered with Click Fit PRO, Verve PRO 8 ensures fast, seamless installation for trade professionals who demand quality.

FINISHES:

SILVER

MATTE BLACK

BRUSHED BRASS

KEY FEATURES:

<p>UP TO 8mm TOUGHENED SAFETY GLASS</p>	<p>1950mm HEIGHT</p>	<p>UP TO 50mm PRODUCT ADJUSTMENT</p>	
<p>HANDLE ON INSIDE AND OUTSIDE OF ENCLOSURE FOR EASE OF OPENING</p>	<p>POSITIVE MAGNETIC CLOSE ACTION</p>	<p>CLEARVUE GLASS COATING</p>	<p>QUICK RELEASE CHROME DOUBLE WHEEL ROLLERS</p>
<p>30mm WALL PROFILE EXTENSION AVAILABLE</p>	<p>CHROME PLATED COVER CAPS</p>	<p>REVERSIBLE FOR LEFT OR RIGHT HANDED INSTALLATION</p>	<p>20 YEAR GUARANTEE</p>

SILVER

MATTE BLACK

BRUSHED BRASS



DESIGNED FOR
EVERYDAY LUXURY.

VERVE PRO 8

VERVE PRO 8

1 DOOR QUADRANT & 1 DOOR OFFSET QUADRANT

CLICK FIT
PRO

FINISHES:

SILVER

MATTE BLACK

BRUSHED BRASS



1 DOOR OFFSET QUADRANT
(LEFT HAND) - BRUSHED BRASS

HANDLE DETAIL -
BRUSHED BRASS



VERVE PRO 8 – 1 DOOR QUADRANT

SIZE (mm)	ADJUSTMENT SIZE		ACCESS (mm)	CODE	CODE	CODE
	MIN (mm)	MAX (mm)		SILVER	BLACK	BRUSHED BRASS
900	870	895	490	V8OCQ90SC	V8OCQ90BC	V8OCQ90BRBC

VERVE PRO 8 – 1 DOOR OFFSET QUADRANT

SIZE (mm)	ADJUSTMENT SIZE		ACCESS (mm)	CODE	CODE	CODE
	MIN (mm)	MAX (mm)		SILVER	BLACK	BRUSHED BRASS
800 x 1000	770-795	970-995	490	V8OCQ80X100SC	—	—
800 x 1200	770-795	1170-1195	490	V8OCQ80X120SC	V8OCQ80X120BC	V8OCQ80X120BRBC
900 x 1200	870-895	1170-1195	490	V8OCQ90X120SC	V8OCQ90X120BC	V8OCQ90X120BRBC

*All Flair Quadrant and Offset Quadrant trays have a 550mm radius.



DESIGNED FOR
EVERYDAY LUXURY.

1 DOOR QUADRANT
(LEFT HAND) - MATTE BLACK

VERVE PRO 8 SLIDING DOOR

CLICK FIT
PRO

FINISHES:

SILVER

MATTE BLACK

BRUSHED BRASS



QUICK
RELEASE
CHROME
DOUBLE
WHEEL
ROLLERS



SLIDING DOOR IN ALCOVE - SILVER

VERVE PRO 8 – SLIDING DOOR

SIZE (mm)	ADJUSTMENT SIZE		ACCESS (mm)	CODE	CODE	CODE
	MIN (mm)	MAX (mm)		SILVER	BLACK	BRUSHED BRASS
1200	1150	1200	475	V8SA120SC	V8SA120BC	V8SA120BRBC
1400	1350	1400	575	V8SA140SC	V8SA140BC	V8SA140BRBC
1500	1450	1500	575	V8SA150SC	V8SA150BC	V8SA150BRBC

VERVE PRO 8 – FRAMELESS SIDE PANELS

SIZE (mm)	ADJUSTMENT SIZE		CODE	CODE	CODE
	MIN (mm)	MAX (mm)	SILVER	BLACK	BRUSHED BRASS
700	670	695	V8SP70SC	V8SP70BC	V8SP70BRBC*
760	730	755	V8SP76SC	V8SP76BC	V8SP76BRBC*
800	770	795	V8SP80SC	V8SP80BC	V8SP80BRBC
900	870	895	V8SP90SC	V8SP90BC	V8SP90BRBC
1000	970	995	V8SP100SC	V8SP100BC*	V8SP100BRBC*

VERVE PRO 8 – PROFILE EXTENSION

DESCRIPTION	CODE	CODE	CODE
	SILVER	BLACK	BRUSHED BRASS
30mm Compensating Wall Profile	V8CB30SC	V8CB30BC	V8CB30BRBC

*Available June 2025



DESIGNED FOR
EVERYDAY LUXURY.

SLIDING DOOR WITH FRAMELESS
SIDE PANEL - BRUSHED BRASS

VERVE PRO 8 PIVOT DOOR

FINISHES:

SILVER MATTE BLACK

BRUSHED BRASS



HANDLE DETAIL -
MATTE BLACK



PIVOT DOOR WITH
INLINE PANEL -
MATTE BLACK

VERVE PRO 8 – PIVOT DOOR

SIZE (mm)	ADJUSTMENT SIZE		ACCESS (mm)	CODE	CODE	CODE
	MIN (mm)	MAX (mm)		SILVER	BLACK	BRUSHED BRASS
700	650	700	417	V8PD70SC*	V8PD70BC*	V8PD70BRBC
800	750	800	517	V8PD80SC	V8PD80BC	V8PD80BRBC
900	850	900	617	V8PD90SC	V8PD90BC	V8PD90BRBC*

VERVE PRO 8 – FRAMELESS SIDE PANELS

SIZE (mm)	ADJUSTMENT SIZE		CODE	CODE	CODE
	MIN (mm)	MAX (mm)	SILVER	BLACK	BRUSHED BRASS
700	670	695	V8SP70SC	V8SP70BC	V8SP70BRBC*
760	730	755	V8SP76SC	V8SP76BC	V8SP76BRBC*
800	770	795	V8SP80SC	V8SP80BC	V8SP80BRBC
900	870	895	V8SP90SC	V8SP90BC	V8SP90BRBC
1000	970	995	V8SP100SC	V8SP100BC*	V8SP100BRBC*

VERVE PRO 8 – INLINE PANELS

SIZE (mm)	CODE	CODE	CODE
	SILVER	BLACK	BRUSHED BRASS
300	V8IL30SC	V8IL30BC	V8IL30BRBC
400	V8IL40SC	V8IL40BC	V8IL40BRBC*

VERVE PRO 8 – PROFILE EXTENSION

DESCRIPTION	CODE	CODE	CODE
	SILVER	BLACK	BRUSHED BRASS
30mm Compensating Wall Profile	V8CB30SC	V8CB30BC	V8CB30BRBC

*Available June 2025



DESIGNED FOR
EVERYDAY LUXURY.

PIVOT DOOR WITH FRAMELESS
SIDE PANEL - SILVER

EXCEPTIONAL
EVERYDAY.



VERVE PRO

Verve PRO collection – a trusted favourite featuring durable 6mm glass, designed to deliver exceptional performance for everyday projects.

Engineered with the Verve Click Fit PRO assembly system, it ensures quick and hassle-free installation, making it the installers choice.

Available in timeless Silver and Matte Black, Verve PRO combines practicality with effortless style, making it a staple for every bathroom space.

Proven and dependable, Verve PRO is the perfect balance of quality and efficiency for trade professionals.

FINISHES:

SILVER

MATTE BLACK

KEY FEATURES:

<p>6mm</p> <p>TOUGHENED SAFETY GLASS</p>	<p>1900mm</p> <p>HEIGHT</p>	<p>UP TO 50mm</p> <p>PRODUCT ADJUSTMENT</p>	
<p>SOLID CHROME HANDLE DESIGN</p>	<p>POSITIVE MAGNETIC CLOSE ACTION</p>	<p>CLEARVUE GLASS COATING</p>	<p>QUICK RELEASE CHROME DOUBLE WHEEL ROLLERS</p>
<p>30mm WALL PROFILE EXTENSION AVAILABLE</p>	<p>CHROME PLATED COVER CAPS</p>	<p>REVERSIBLE FOR LEFT OR RIGHT HANDED INSTALLATION</p>	<p>20 YEAR GUARANTEE</p>

VERVE PRO

1 DOOR QUADRANT & 1 DOOR OFFSET QUADRANT

**CLICK FIT
PRO**

FINISHES:

SILVER

MATTE BLACK



1 DOOR QUADRANT
(RIGHT HAND) - MATTE BLACK

QUICK RELEASE
CHROME DOUBLE
WHEEL ROLLERS



VERVE PRO – 1 DOOR QUADRANT

SIZE (mm)	ADJUSTMENT SIZE		ACCESS (mm)	CODE	CODE
	MIN (mm)	MAX (mm)		SILVER	BLACK
800	770	795	435	VOCQ80SC	VOCQ80BC
900	870	895	490	VOCQ90SC	VOCQ90BC
1000	970	995	490	VOCQ100SC	VOCQ100BC

VERVE PRO – 1 DOOR OFFSET QUADRANT

SIZE (mm)	ADJUSTMENT SIZE		ACCESS (mm)	CODE	CODE
	MIN (mm)	MAX (mm)		SILVER	BLACK
760 x 900	730-755	870-895	490	VOCQ76X90SC	VOCQ76X90BC
800 x 900	770-795	870-895	490	VOCQ80X90SC	–
800 x 1000	770-795	970-995	490	VOCQ80X100SC	VOCQ80X100BC
900 x 1000	870-895	970-995	490	VOCQ90X100SC	–
800 x 1200	770-795	1170-1195	490	VOCQ80X120SC	VOCQ80X120BC
900 x 1200	870-895	1170-1195	490	VOCQ90X120SC	VOCQ90X120BC

*All Flair Quadrant and Offset Quadrant trays have a 550mm radius.



EXCEPTIONAL
EVERYDAY.

1 DOOR OFFSET
QUADRANT
(LEFT HAND) -
SILVER

VERVE PRO

2 DOOR QUADRANT & 2 DOOR OFFSET QUADRANT

CLICK FIT
PRO

FINISHES:
SILVER



SOLID CHROME PLATED HANDLES

2 DOOR OFFSET QUADRANT - SILVER

VERVE PRO – 2 DOOR QUADRANT

SIZE (mm)	ADJUSTMENT SIZE MIN (mm)	ADJUSTMENT SIZE MAX (mm)	ACCESS (mm)	CODE SILVER
800	770	795	385	VCQ80SC
900	870	895	538	VCQ90SC

VERVE PRO – 2 DOOR OFFSET QUADRANT

SIZE (mm)	ADJUSTMENT SIZE MIN (mm)	ADJUSTMENT SIZE MAX (mm)	ACCESS (mm)	CODE SILVER
800 x 1000	770-795	970-995	468	VCQ80X100SC
800 x 1100	770-795	1070-1095	468	VCQ80X110SC
800 x 1200	770-795	1170-1195	468	VCQ80X120SC
900 x 1100	870-895	1070-1095	538	VCQ90X110SC
900 x 1200	870-895	1170-1195	538	VCQ90X120SC

*All Flair Quadrant and Offset Quadrant trays have a 550mm radius.

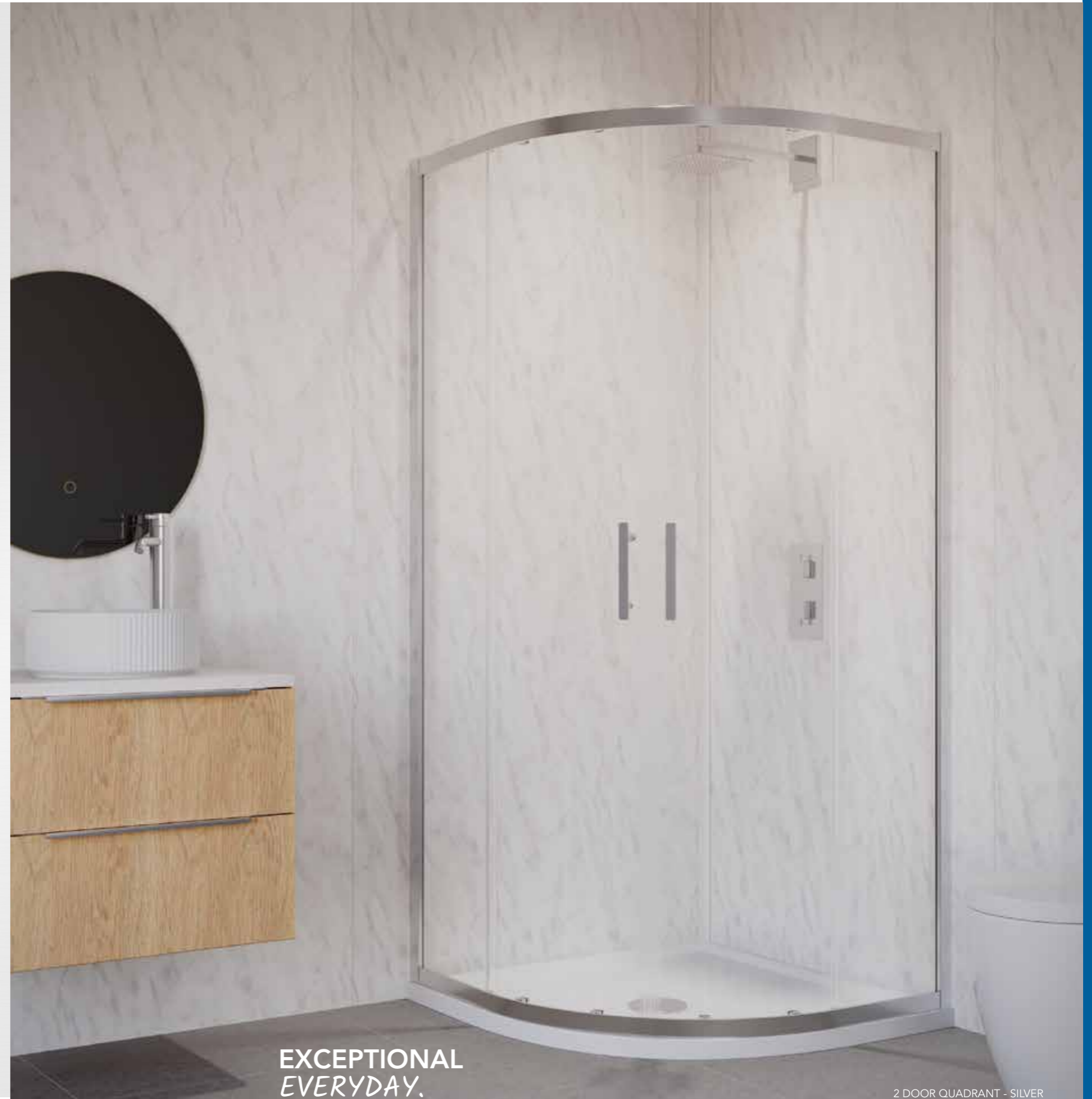

EXCEPTIONAL
EVERYDAY.

2 DOOR QUADRANT - SILVER

VERVE PRO SLIDING DOOR

**CLICK FIT
PRO**

FINISHES:

SILVER

MATTE BLACK



SOLID
CHROME
PLATED
HANDLES



SLIDING DOOR IN SILVER IN ALCOVE

VERVE PRO - SLIDING DOOR

SIZE (mm)	ADJUSTMENT SIZE MIN (mm)	ADJUSTMENT SIZE MAX (mm)	ACCESS (mm)	CODE SILVER	CODE BLACK
1000	950	1000	375	VSA100SC	VSA100BC
1100	1050	1100	425	VSA110SC	VSA110BC
1200	1150	1200	475	VSA120SC	VSA120BC
1300	1250	1300	525	VSA130SC	VSA130BC
1400	1350	1400	575	VSA140SC	VSA140BC
1500	1450	1500	575	VSA150SC	VSA150BC
1600	1550	1600	575	VSA160SC	VSA160BC
1700	1650	1700	575	VSA170SC	VSA170BC
1800	1750	1800	575	VSA180SC	—

VERVE PRO - SEMI FRAMED SIDE PANELS

SIZE (mm)	ADJUSTMENT SIZE MIN (mm)	ADJUSTMENT SIZE MAX (mm)	ACCESS (mm)	CODE SILVER	CODE BLACK
700	670	695		VSP70SC	VSP70BC
760	730	755		VSP76SC	VSP76BC
800	770	795		VSP80SC	VSP80BC
900	870	895		VSP90SC	VSP90BC
1000	970	995		VSP100SC	VSP100BC

30mm compensating wall profile included with every Verve Side Panel
Please note, when using a side panel, the maximum door adjustment is reduced by 25mm.

VERVE PRO - PROFILE EXTENSION

SIZE (mm)	CODE SILVER	CODE BLACK
30mm Compensating Wall Profile	VCB30SC	VCB30BC



EXCEPTIONAL
EVERYDAY.

SLIDING DOOR WITH SEMI FRAMED
SIDE PANEL - MATTE BLACK

VERVE PRO

LEVEL ACCESS SLIDING DOOR

CLICK FIT
PRO

FINISHES:
SILVER

VERVE PRO - LEVEL ACCESS SLIDING DOOR

SIZE (mm)	ADJUSTMENT SIZE		ACCESS (mm)	CODE
	MIN (mm)	MAX (mm)		
1000 - Left Hand	950	1000	380	VSASS100LSC
1000 - Right Hand	950	1000	380	VSASS100RSC
1100 - Left Hand	1050	1100	430	VSASS110LSC
1100 - Right Hand	1050	1100	430	VSASS110RSC
1200 - Left Hand	1150	1200	480	VSASS120LSC
1200 - Right Hand	1150	1200	480	VSASS120RSC
1300 - Left Hand	1250	1300	530	VSASS130LSC
1300 - Right Hand	1250	1300	530	VSASS130RSC
1400 - Left Hand	1350	1400	580	VSASS140LSC
1400 - Right Hand	1350	1400	580	VSASS140RSC
1500 - Left Hand	1450	1500	580	VSASS150LSC
1500 - Right Hand	1450	1500	580	VSASS150RSC
1600 - Left Hand	1550	1600	580	VSASS160LSC
1600 - Right Hand	1550	1600	580	VSASS160RSC
1700 - Left Hand	1650	1700	580	VSASS170LSC
1700 - Right Hand	1650	1700	580	VSASS170RSC
1800 - Left Hand	1750	1800	580	VSASS180LSC
1800 - Right Hand	1750	1800	580	VSASS180RSC

VERVE PRO - SEMI FRAMED SIDE PANELS

SIZE (mm)	ADJUSTMENT SIZE		CODE
	MIN (mm)	MAX (mm)	
700	670	695	VSP70SC
760	730	755	VSP76SC
800	770	795	VSP80SC
900	870	895	VSP90SC
1000	970	995	VSP100SC

30mm Compensating Wall Profile included with every Verve Side Panel
Please note, when using a side panel, the maximum door adjustment is reduced by 25mm.

VERVE PRO - PROFILE EXTENSION

DESCRIPTION	CODE
30mm Compensating Wall Profile	VCB30SC



LEVEL ACCESS SLIDING DOOR (LEFT HAND) IN ALCOVE

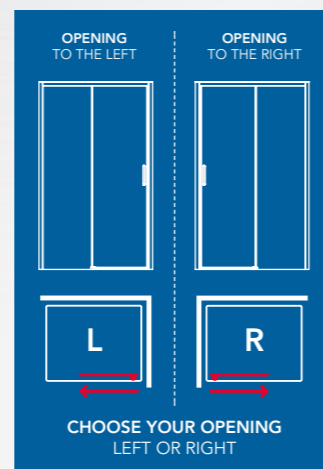

VSASS FEATURES AN ANTI-JUMP MECHANISM ENSURING DOOR REMAINS SECURELY ON THE TRACKS



EXCEPTIONAL
EVERYDAY.

LEVEL ACCESS SLIDING DOOR (RIGHT HAND) WITH SIDE PANEL

VERVE PRO TRIPLE PANEL SLIDING DOOR

FINISHES:

SILVER



TRIPLE PANEL SLIDING DOOR IN ALCOVE

VERVE PRO - TRIPLE PANEL SLIDING DOOR

SIZE (mm)	ADJUSTMENT SIZE		ACCESS (mm)	CODE
	MIN (mm)	MAX (mm)		
900	850	900	430	V3SA90SC
1000	950	1000	497	V3SA100SC
1100	1050	1100	563	V3SA110SC
1200	1150	1200	630	V3SA120SC

VERVE PRO - SEMI FRAMED SIDE PANELS

SIZE (mm)	ADJUSTMENT SIZE		CODE
	MIN (mm)	MAX (mm)	
700	670	695	VSP70SC
760	730	755	VSP76SC
800	770	795	VSP80SC
900	870	895	VSP90SC
1000	970	995	VSP100SC

30mm compensating wall profile included with every Verve Side Panel
Please note, when using a side panel, the maximum door adjustment is reduced by 25mm.

VERVE PRO - PROFILE EXTENSION

DESCRIPTION	CODE
30mm Compensating Wall Profile	VCB30SC

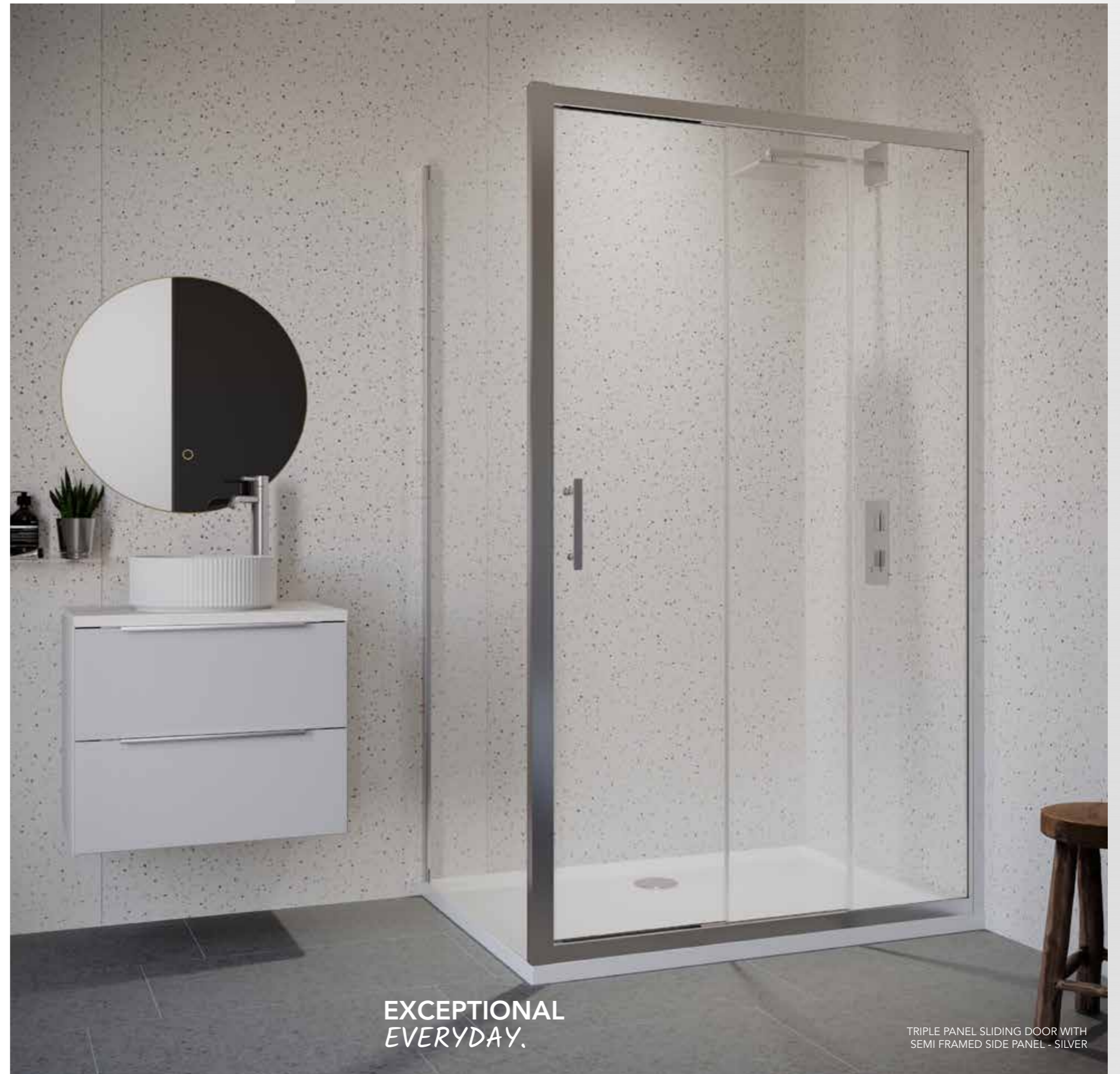

EXCEPTIONAL
EVERYDAY.

TRIPLE PANEL SLIDING DOOR WITH SEMI FRAMED SIDE PANEL - SILVER

VERVE PRO BIFOLD DOOR

FINISHES:

SILVER MATTE BLACK



BIFOLD DOOR WITH SEMI FRAMED SIDE PANEL - SILVER

VERVE PRO - BIFOLD DOOR

SIZE (mm)	ADJUSTMENT SIZE		ACCESS (mm)	CODE	CODE
	MIN (mm)	MAX (mm)		SILVER	BLACK
700	650	700	413	VBF70SC	VBF70BC
760	710	760	473	VBF76SC	-
800	750	800	513	VBF80SC	VBF80BC
900	850	900	613	VBF90SC	VBF90BC
1000	950	1000	713	VBF100SC	VBF100BC

VERVE PRO - SEMI FRAMED SIDE PANELS

SIZE (mm)	ADJUSTMENT SIZE		CODE	CODE
	MIN (mm)	MAX (mm)	SILVER	BLACK
700	670	695	VSP70SC	VSP70BC
760	730	755	VSP76SC	VSP76BC
800	770	795	VSP80SC	VSP80BC
900	870	895	VSP90SC	VSP90BC
1000	970	995	VSP100SC	VSP100BC

30mm compensating wall profile included with every Verve Side Panel
Please note, when using a side panel, the maximum door adjustment is reduced by 25mm.

VERVE PRO - INLINE PANELS

SIZE (mm)	CODE	CODE
	SILVER	BLACK
200	VIL20SC	VIL20BC
300	VIL30SC	VIL30BC
400	VIL40SC	VIL40BC
500	VIL50SC	VIL50BC

VERVE PRO - PROFILE EXTENSION

DESCRIPTION	CODE	CODE
	SILVER	BLACK
30mm Compensating Wall Profile	VCB30SC	VCB30BC



EXCEPTIONAL
EVERYDAY.

BIFOLD DOOR IN ALCOVE - MATE BLACK

VERVE PRO CORNER ENTRY

CLICK FIT
PRO

FINISHES:

SILVER

MATTE BLACK



QUICK RELEASE
CHROME DOUBLE
WHEEL ROLLERS



CORNER ENTRY -
SILVER

VERVE PRO - CORNER ENTRY

SIZE (mm)	ADJUSTMENT SIZE		ACCESS (mm)	CODE	CODE
	MIN (mm)	MAX (mm)		SILVER	BLACK
700	670	695	340	VCE70SSC	-
760	730	755	382	VCE76SSC	-
800	770	795	410	VCE80SSC	VCE80SBC
900	870	895	481	VCE90SSC	VCE90SBC
1000	970	995	551	VCE100SSC	-



EXCEPTIONAL
EVERYDAY.

CORNER ENTRY - MATTE BLACK

VERVE PRO PIVOT DOOR

FINISHES:

SILVER MATTE BLACK



PIVOT DOOR WITH INLINE PANEL CLOSING ONTO SEMI FRAMED SIDE PANEL - SILVER

VERVE PRO - PIVOT DOOR

SIZE (mm)	ADJUSTMENT SIZE		ACCESS (mm)	CODE SILVER	CODE BLACK
	MIN (mm)	MAX (mm)			
700	650	700	417	VPD70SC	–
760	710	760	477	VPD76SC	–
800	750	800	517	VPD80SC	VPD80BC
900	850	900	617	VPD90SC	VPD90BC
1000	950	1000	717	VPD100SC	VPD100BC

VERVE PRO - SEMI FRAMED SIDE PANELS

SIZE (mm)	ADJUSTMENT SIZE		CODE SILVER	CODE BLACK
	MIN (mm)	MAX (mm)		
700	670	695	VSP70SC	VSP70BC
760	730	755	VSP76SC	VSP76BC
800	770	795	VSP80SC	VSP80BC
900	870	895	VSP90SC	VSP90BC
1000	970	995	VSP100SC	VSP100BC

30mm compensating wall profile included with every Verve Side Panel
Please note, when using a side panel, the maximum door adjustment is reduced by 25mm.

VERVE PRO - INLINE PANELS

SIZE (mm)	CODE SILVER	CODE BLACK
200	VIL20SC	VIL20BC
300	VIL30SC	VIL30BC
400	VIL40SC	VIL40BC
500	VIL50SC	VIL50BC

VERVE PRO - PROFILE EXTENSION

DESCRIPTION	CODE SILVER	CODE BLACK
30mm Compensating Wall Profile	VCB30SC	VCB30BC



EXCEPTIONAL
EVERYDAY.

PIVOT DOOR WITH SEMI FRAMED SIDE PANEL - MATTE BLACK



VERVE PRO WETROOMS

Choose a Verve PRO wetroom for a luxurious walk-in shower experience. These versatile screens are suitable for shower tray or wetroom floor application.

Verve PRO wetroom panels are constructed from 8mm toughened safety glass and offer superb quality.

FINISHES:



VERVE PRO WETROOM SCREENS

FINISHES:

SILVER MATTE BLACK

BRUSHED BRASS

KEY FEATURES

8mm
TOUGHENED
SAFETY GLASS

2000mm
HEIGHT

CLEARVUE
GLASS
COATING

UP TO
15mm
PRODUCT
ADJUSTMENT

1m CHROME
STABILISING BAR
INCLUDED

SUITABLE FOR
SHOWER TRAY OR
WETROOM FLOOR
APPLICATION



WETROOM WITH ROTATING PANEL & T-PIECE STABILISING BAR - MATTE BLACK

VERVE PRO - WETROOMS

SIZE (mm)	ADJUSTMENT SIZE		CODE SILVER	CODE BLACK	CODE BRUSHED BRASS
	MIN (mm)	MAX (mm)			
600	575	590	RWR60SCV	RWR60BCV	RWR60BRBCV
700	675	690	RWR70SCV	RWR70BCV	RWR70BRBCV
800	775	790	RWR80SCV	RWR80BCV	RWR80BRBCV
900	875	890	RWR90SCV	RWR90BCV	RWR90BRBCV
1000	975	990	RWR100SCV	RWR100BCV	RWR100BRBCV
1100	1075	1090	RWR110SCV	RWR110BCV	RWR110BRBCV
1200	1175	1190	RWR120SCV	RWR120BCV	RWR120BRBCV
1400	1375	1390	RWR140SCV	RWR140BCV	RWR140BRBCV

30mm compensating wall profile included with every Verve Side Panel
Please note, when using a side panel, the maximum door adjustment is reduced by 25mm.

VERVE PRO - ROTATING WETROOM PANELS

SIZE (mm)	ADJUSTMENT SIZE		CODE SILVER	CODE BLACK	CODE BRUSHED BRASS
	MIN (mm)	MAX (mm)			
300	675	690	RRP30SCV	RRP30BCV	RRP30BRBCV
400	775	790	RRP40SCV	RRP40BCV	RRP40BRBCV

Please Note - Rotating wetroom panel sold separately.

VERVE PRO - T-PIECE STABILISING BAR

DESCRIPTION	CODE SILVER	CODE BLACK	CODE BRUSHED BRASS
	T-Piece	S-RWRTS	S-RWRTBLK

Purchased separately if fitted with a side panel.



EXCEPTIONAL
EVERYDAY.

WETROOM WITH T-PIECE STABILISING BAR - BRUSHED BRASS



VERVE PRO BATHSCREENS

Featuring a versatile collection of 8mm and 6mm screens, Verve PRO bathscreens are each crafted to deliver exceptional durability and performance, our collection offers multiple styles to suit modern and classic spaces - something for every design preference.

FINISHES:

- SILVER
- MATTE BLACK
- BRUSHED BRASS
- BRUSHED NICKEL

8mm
TOUGHENED
SAFETY GLASS

6mm
TOUGHENED
SAFETY GLASS

UP TO
1500mm
HEIGHT

VERVE PRO 8

8MM BATHSCREENS

FINISHES:

- SILVER
- MATTE BLACK**
- BRUSHED BRASS
- BRUSHED NICKEL



8MM 2 PANEL BATHSCREEN (1 FIXED PANEL / 1 ROTATING PANEL - SQUARE EDGE) - MATTE BLACK

VERVE PRO - 8MM BATHSCREENS

DESCRIPTION	HEIGHT MIN (mm)	WIDTH MAX (mm)	COLOUR	CODE
8mm 2 Panel Bathscreen - 1 Fixed Panel / Rotating Panel - Square Edge	1500	900	Silver	VBSI3SC
8mm 2 Panel Bathscreen - 1 Fixed Panel / Rotating Panel - Square Edge	1500	900	Matte Black	VBSI3BC
8mm 2 Panel Bathscreen - 1 Fixed Panel / Rotating Panel - Square Edge	1500	900	Brushed Brass	VBSI3BRBC
8mm 2 Panel Bathscreen - 1 Fixed Panel / Rotating Panel - Square Edge	1500	900	Brushed Nickel	VBSI3BRNC*

*Available July 2025

KEY FEATURES

- 8mm**
TOUGHENED SAFETY GLASS
- 1500mm**
HEIGHT
- CLEARVUE GLASS COATING
- MAGNETIC SEALS
- INWARD ROTATING PANEL UP TO 180°
- UNIVERSAL FOR LEFT OR RIGHT HANDED OPENING
- 20 YEAR GUARANTEE

IMPORTANT NOTE:
 - These Bathscreens are a water deflector and splash proof only.
 - It is advised that all Bathscreens are fitted to the inside edge of the bath to ensure maximum effectiveness.

NEW BRUSHED NICKEL FINISH

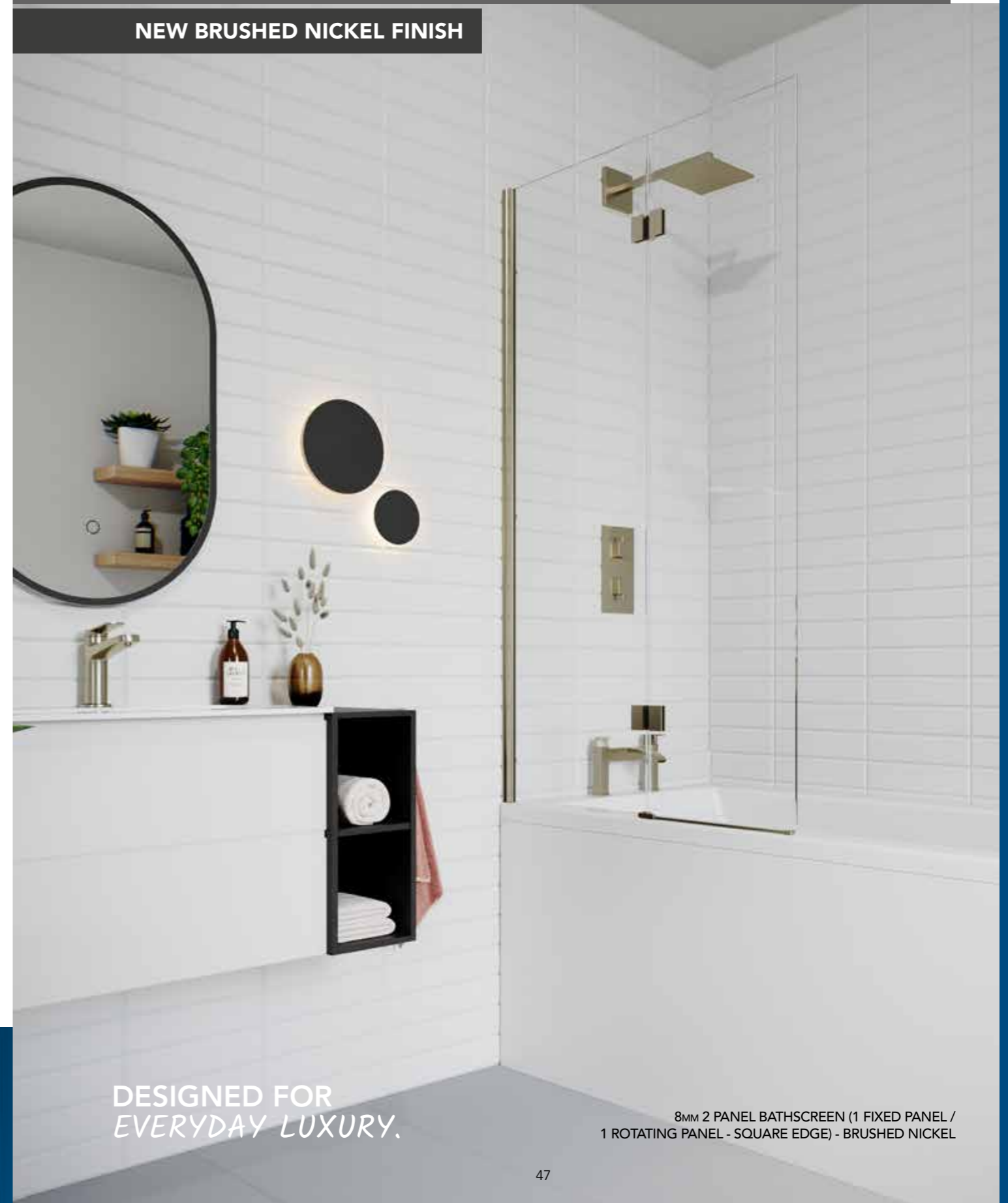

DESIGNED FOR
EVERYDAY LUXURY.

8MM 2 PANEL BATHSCREEN (1 FIXED PANEL / 1 ROTATING PANEL - SQUARE EDGE) - BRUSHED NICKEL

VERVE PRO

6MM CURVED BATHSCREENS

FINISHES:

SILVER

MATTE BLACK

BRUSHED BRASS



6MM SAIL BATHSCREEN WITH TOWEL RAIL - VBS12SC



6MM 1 FIXED & 1 ROTATING PANEL CURVED EDGE - VBS75C



6MM ROTATING BATHSCREEN CURVED EDGE WITH TOWEL RAIL - VBS35C

VERVE PRO - CURVED BATHSCREENS

DESCRIPTION	HEIGHT MIN (mm)	WIDTH MAX (mm)	COLOUR	CODE
6mm Rotating Bathscreen - Curved Edge	1400	800	Silver	VBS15C
6mm Rotating Bathscreen - Curved Edge	1400	800	Matte Black	VBS16C
6mm Rotating Bathscreen - Curved Edge	1400	800	Brushed Brass	VBS16RBC
6mm Rotating Bathscreen - Curved Edge with Towel Rail	1500	800	Silver	VBS35C*
6mm Fixed & Rotating Panel - Curved Edge	1500	900	Silver	VBS75C
6mm Sail Bathscreen with Towel Rail	1500	800	Silver	VBS125C*

*While stocks last

KEY FEATURES

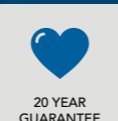
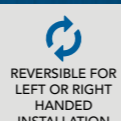

IMPORTANT NOTE:

- These Bathscreens are a water deflector and splash proof only.
- It is advised that all Bathscreens are fitted to the inside edge of the bath to ensure maximum effectiveness.

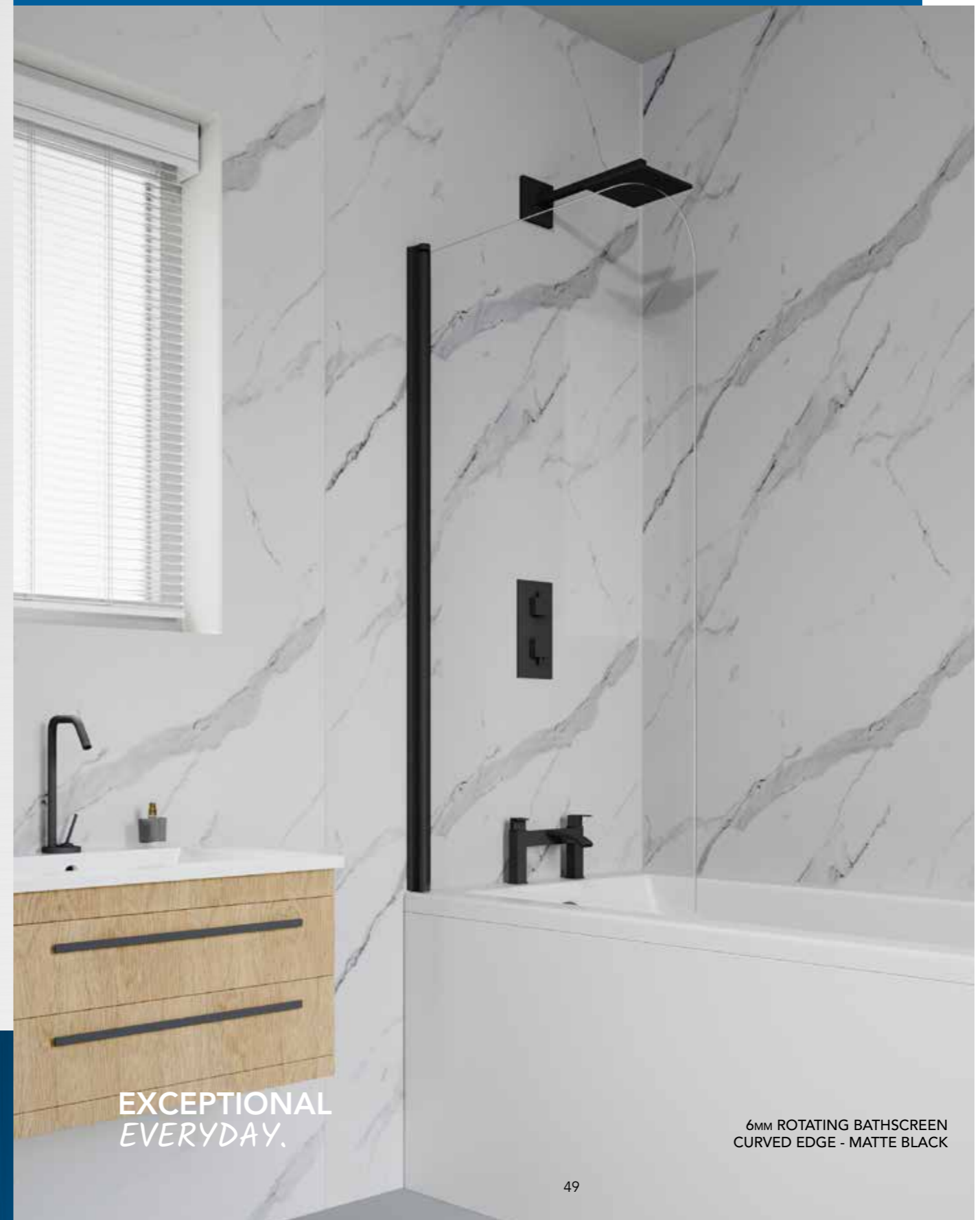

EXCEPTIONAL EVERYDAY.

6MM ROTATING BATHSCREEN CURVED EDGE - MATTE BLACK

VERVE PRO

6MM SQUARE BATHSCREENS

FINISHES:

SILVER

BRUSHED BRASS

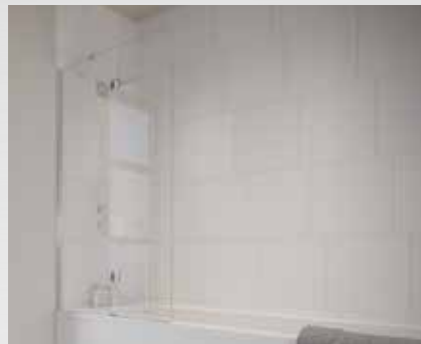

6MM 2 PANEL BATHSCREEN - 1 FIXED & 1 ROTATING PANEL - VBS8SC



6MM FIXED BATHSCREEN DEFLECTOR 300MM - VBSG30SC



6MM FIXED BATHSCREEN WITH CHROME ANGLED SUPPORT BAR - VBS10SC

VERVE PRO - SQUARE BATHSCREENS

DESCRIPTION	HEIGHT MIN (mm)	WIDTH MAX (mm)	COLOUR	CODE
6mm 2 Panel Bathscreen - 1 Fixed & 1 Rotating Panel	1500	900	Silver	VBS8SC
6mm Rotating Bathscreen - Square Edge	1400	800	Silver	VBS2SC
6mm Rotating Bathscreen - Square Edge	1400	800	Brushed Brass	VBS2BRBC
6mm Fixed Bathscreen with Chrome Angled Support Bar	1400	850	Silver	VBS10SC
6mm Fixed Bathscreen Deflector 300mm	1500	300	Silver	VBSG30SC

IMPORTANT NOTE:

- These Bathscreens are a water deflector and splash proof only.
- It is advised that all Bathscreens are fitted to the inside edge of the bath to ensure maximum effectiveness.

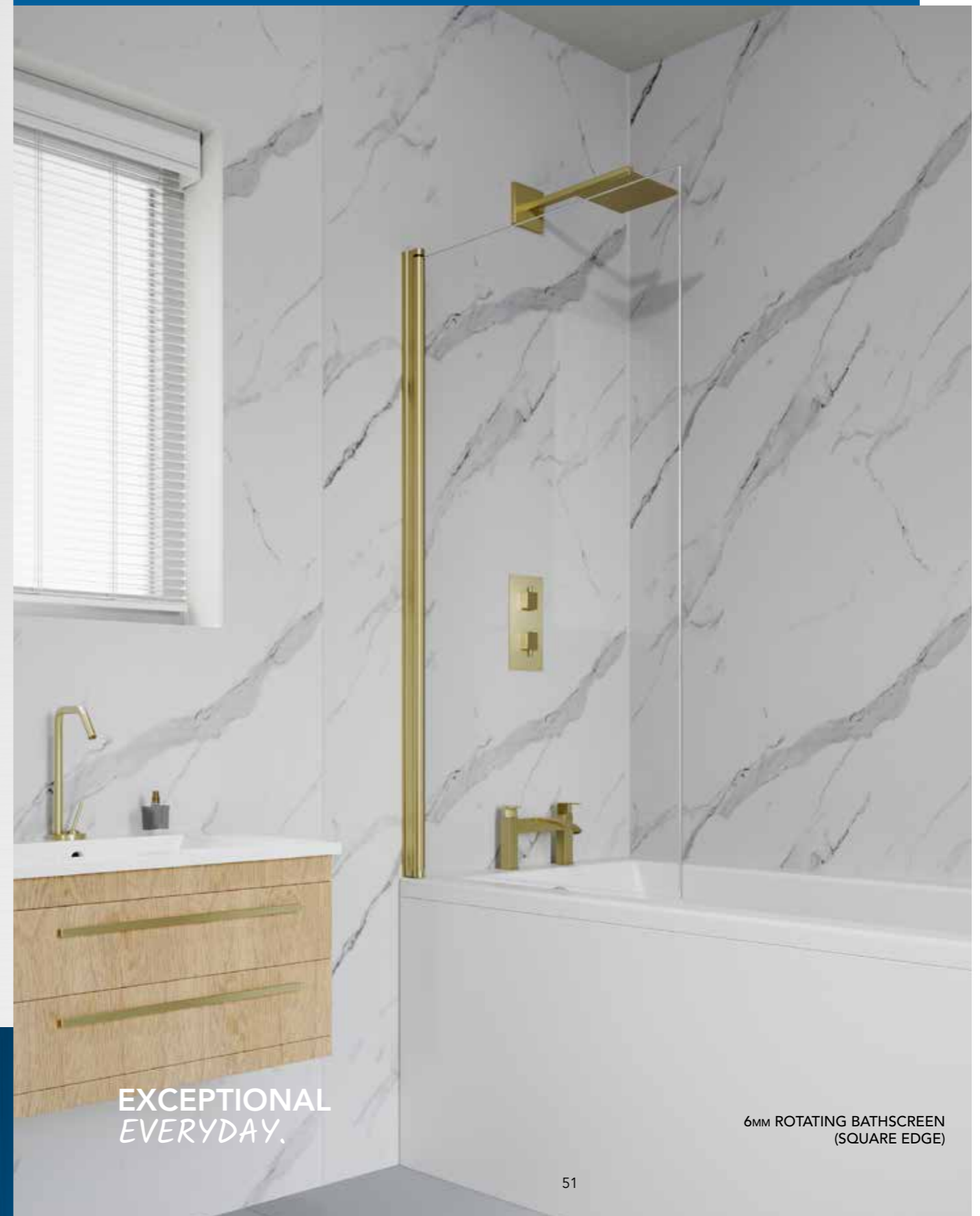

EXCEPTIONAL
EVERYDAY.

6MM ROTATING BATHSCREEN (SQUARE EDGE)

KEY FEATURES

6E

TOUGHENED SAFETY GLASS

UP TO 1500mm HEIGHT

CLEARVUE GLASS COATING

UP TO 15mm PRODUCT ADJUSTMENT

REVERSIBLE FOR LEFT OR RIGHT HANDED INSTALLATION

20 YEAR GUARANTEE



EXCEPTIONAL
EVERYDAY.



SLIMLINE TELESCOPIC

Slimline Telescopic is the ultimate solution to making installation simple. With a selection of doors that boasts a total adjustment of up to 100mm, Slimline Telescopic offers flexibility with adjustable wall profiles allowing the shower enclosure to fit perfectly even when the walls are not completely plum.

With adjustable wall profiles for a perfect fit and a silent roller mechanism for smooth, quiet operation, the collection is a dependable, and the hassle-free solution.

FINISHES:

SILVER

KEY FEATURES:

<p>6mm</p> <p>TOUGHENED SAFETY GLASS</p>	<p>1950mm</p> <p>HEIGHT</p>	<p>UP TO 100mm</p> <p>PRODUCT ADJUSTMENT</p>	
<p>PATENTED TWIST + LOCK ADJUSTMENT MECHANISM</p>	<p>25mm WALL PROFILE EXTENSION AVAILABLE</p>	<p>CLEAN EASY GLASS COATING</p>	<p>INNOVATIVE SILENT WHEEL TRACK SYSTEM</p>
<p>SPARE PARTS AVAILABLE</p>	<p>REVERSIBLE FOR LEFT OR RIGHT HANDED INSTALLATION</p>	<p>20 YEAR GUARANTEE</p>	

SLIMLINE TELESCOPIC PIVOT DOOR

FINISHES:

SILVER



UP TO 100 mm PRODUCT ADJUSTMENT

SLIMLINE TELESCOPIC - PIVOT DOOR

SIZE (mm)	ADJUSTMENT SIZE		ACCESS (mm)	CODE
	MIN (mm)	MAX (mm)		SILVER
800	700	800	422	STPD80SC
900	800	900	522	STPD90SC
1000	900	1000	622	STPD100SC
1200	1100	1200	622	STPD120SC

SLIMLINE TELESCOPIC - SEMI FRAMED SIDE PANELS

SIZE (mm)	ADJUSTMENT SIZE		CODE
	MIN (mm)	MAX (mm)	SILVER
700	670	690	STSP70SC
760	730	750	STSP76SC
800	770	790	STSP80SC
900	870	890	STSP90SC
1000	970	990	STSP100SC
1100	1070	1090	STSP110SC
1200	1170	1190	STSP120SC

SLIMLINE TELESCOPIC - PROFILE EXTENSION

DESCRIPTION	CODE
	SILVER
25mm Compensating Wall Profile	STPACKDSC



SLEEK POLISHED CHROME HANDLES



MINIMALIST CHROME PROFILES AND PIVOT HINGE



EXCEPTIONAL EVERYDAY.

PIVOT DOOR WITH SEMI FRAMED SIDE PANEL - SILVER

SLIMLINE TELESCOPIC SLIDING DOOR

FINISHES:

SILVER



SLIMLINE TELESCOPIC - SLIDING DOOR

SIZE (mm)	ADJUSTMENT SIZE		ACCESS (mm)	CODE
	MIN (mm)	MAX (mm)		SILVER
1000	940	1000	378	STSA100SC
1100	1040	1100	428	STSA110SC
1200	1140	1200	478	STSA120SC
1300	1200	1300	488	STSA130SC
1400	1300	1400	538	STSA140SC
1500	1400	1500	588	STSA150SC

SLIMLINE TELESCOPIC - SEMI FRAMED SIDE PANELS

SIZE (mm)	ADJUSTMENT SIZE		CODE
	MIN (mm)	MAX (mm)	SILVER
700	670	690	STSP70SC
760	730	750	STSP76SC
800	770	790	STSP80SC
900	870	890	STSP90SC
1000	970	990	STSP100SC
1100	1070	1090	STSP110SC
1200	1170	1190	STSP120SC

SLIMLINE TELESCOPIC - PROFILE EXTENSION

DESCRIPTION	CODE
25mm Compensating Wall Profile	STPACKDSC



EXCEPTIONAL
EVERYDAY.

SLIMLINE TELESCOPIC BIFOLD DOOR

FINISHES:

SILVER



SLIMLINE TELESCOPIC - BIFOLD DOOR

SIZE (mm)	ADJUSTMENT SIZE MIN (mm)	ADJUSTMENT SIZE MAX (mm)	ACCESS (mm)	CODE SILVER
700	630	700	358	STBF70SC
800	730	800	428	STBF80SC
900	800	900	498	STBF90SC
1000	900	1000	578	STBF100SC
1100	1000	1100	578	STBF110SC
1200	1100	1200	578	STBF120SC

SLIMLINE TELESCOPIC - SEMI FRAMED SIDE PANELS

SIZE (mm)	ADJUSTMENT SIZE MIN (mm)	ADJUSTMENT SIZE MAX (mm)	CODE SILVER
700	670	690	STSP70SC
760	730	750	STSP76SC
800	770	790	STSP80SC
900	870	890	STSP90SC
1000	970	990	STSP100SC
1100	1070	1090	STSP110SC
1200	1170	1190	STSP120SC

SLIMLINE TELESCOPIC - PROFILE EXTENSION

DESCRIPTION	CODE SILVER
25mm Compensating Wall Profile	STPACKDSC



EXCEPTIONAL EVERYDAY.

BIFOLD DOOR WITH SEMI FRAMED SIDE PANEL - SILVER



EXCEPTIONAL
EVERYDAY.



FRAMELESS SIX

Frameless Six delivers an affordable 6mm glass solution without compromising on quality. Featuring a rising-butt hinge, it ensures smooth opening and closing while preventing seals from dragging or wearing against the floor – perfect for long-term durability.

This cleverly designed collection is suitable for both wetroom and shower tray application.

FINISHES:

SILVER

MATTE BLACK

KEY FEATURES

<p>6mm</p> <p>TOUGHENED SAFETY GLASS</p>	<p>1950mm</p> <p>HEIGHT</p>	<p>UP TO 50mm</p> <p>PRODUCT ADJUSTMENT</p>	
<p>SILVER & MATTE BLACK OPTIONS AVAILABLE <small>SELECTED DOOR STYLES</small></p>	<p>UP TO 25mm WALL PROFILE EXTENSION AVAILABLE</p>	<p>CLEAN EASY GLASS COATING</p>	<p>RISING BUTT HINGE MECHANISM FOR SMOOTH MOVEMENT</p>
<p>SPARE PARTS AVAILABLE</p>	<p>REVERSIBLE FOR LEFT OR RIGHT HANDED INSTALLATION</p>	<p>EASY ACCESS SOLUTION</p>	<p>20 YEAR GUARANTEE</p>

FRAMELESS SIX SALOON DOOR

FINISHES:

SILVER **MATT BLACK**



SALOON DOOR IN
ALCOVE - SILVER

FRAMELESS SIX - SALOON DOOR

SIZE (mm)	ADJUSTMENT SIZE		ACCESS (mm)	CODE	CODE
	MIN (mm)	MAX (mm)		SILVER	BLACK
800	750	800	594	FFSD80SC	FFSD80BC
900	850	900	694	FFSD90SC	FFSD90BC
1000	950	1000	794	FFSD100SC	FFSD100BC
1200	1150	1200	994	FFSD120SC	FFSD120BC

FRAMELESS SIX - SEMI FRAMED SIDE PANELS

SIZE (mm)	ADJUSTMENT SIZE		CODE	CODE
	MIN (mm)	MAX (mm)	SILVER	BLACK
700	665	690	FFSP70SC	FFSP70BC
760	725	750	FFSP76SC	-
800	765	790	FFSP80SC	FFSP80BC
900	865	890	FFSP90SC	FFSP90BC
1000	965	990	FFSP100SC	FFSP100BC
1200	1165	1190	FFSP120SC	FFSP120BC

FRAMELESS SIX - INLINE PANELS

SIZE (mm)	CODE	CODE
	SILVER	BLACK
200	FFIL20SC	FFIL20BC
300	FFIL30SC	FFIL30BC
400	FFIL40SC	FFIL40BC

FRAMELESS SIX - PROFILE EXTENSION

DESCRIPTION	CODE	CODE
	SILVER	BLACK
10mm Compensating Wall Profile	FFCB10SC	FFCB10BG
25mm Compensating Wall Profile	FFCB25SC	FFCB25BG



SALOON DOOR
IN ALCOVE - BLACK

FRAMELESS SIX PIVOT DOOR

FINISHES:

SILVER MATT BLACK



PIVOT DOOR WITH SEMI FRAMED SIDE PANEL - SILVER

FRAMELESS SIX - PIVOT DOOR

SIZE (mm)	ADJUSTMENT SIZE		ACCESS (mm)	CODE	CODE
	MIN (mm)	MAX (mm)		SILVER	BLACK
700	650	700	513	FFPD70SC	FFPD70BC
800	750	800	613	FFPD80SC	FFPD80BC
900	850	900	713	FFPD90SC	FFPD90BC
1000	950	1000	813	FFPD100SC	FFPD100BC

FRAMELESS SIX - SEMI FRAMED SIDE PANELS

SIZE (mm)	ADJUSTMENT SIZE		CODE	CODE
	MIN (mm)	MAX (mm)	SILVER	BLACK
700	665	690	FFSP70SC	FFSP70BC
760	725	750	FFSP76SC	-
800	765	790	FFSP80SC	FFSP80BC
900	865	890	FFSP90SC	FFSP90BC
1000	965	990	FFSP100SC	FFSP100BC
1200	1165	1190	FFSP120SC	FFSP120BC

FRAMELESS SIX - INLINE PANELS

SIZE (mm)	CODE	CODE
	SILVER	BLACK
200	FFIL20SC	FFIL20BC
300	FFIL30SC	FFIL30BC
400	FFIL40SC	FFIL40BC

FRAMELESS SIX - PROFILE EXTENSION

DESCRIPTION	CODE	CODE
	SILVER	BLACK
10mm Compensating Wall Profile	FFCB10SC	FFCB10BG
25mm Compensating Wall Profile	FFCB25SC	FFCB10BG



PIVOT DOOR IN ALCOVE - BLACK

FRAMELESS SIX CORNER PIVOT DOOR

FINISHES:

SILVER



SLEEK POLISHED
CHROME HANDLES

FRAMELESS SIX - CORNER PIVOT DOOR

SIZE (mm)	ADJUSTMENT SIZE		ACCESS (mm)	CODE SILVER
	MIN (mm)	MAX (mm)		
800	765	790	935	FFCPD80SC
900	865	890	1076	FFCPD90SC
1000	965	990	1217	FFCPD100SC



falsafe[™]
TECHNOLOGY
SECURE GLASS SYSTEM

CORNER PIVOT DOOR - SILVER

FRAMELESS SIX HINGED ROTATING WETROOM PANEL

FINISHES:

SILVER



FRAMELESS SIX - HINGED ROTATING WETROOM PANEL

SIZE (mm)	ADJUSTMENT SIZE		CODE SILVER
	MIN (mm)	MAX (mm)	
300	300	325	FFPD30SC
450	450	475	FFPD45SC
600	600	625	FFPD60SC



HINGED ROTATING
WETROOM PANEL - SILVER

TRAYS

Extensive selection of shower tray shapes and sizes to complement your bathroom.

SHOWER TRAY INSTALLATION

All shower trays must be installed as per instructions supplied. Install on a base of fine sand, cement and cement additive. Please note: Silicone sealants, foams, mastics, installation compound adhesive or similar must not be used as a substitute for cement. Ensure shower tray is 100% level and water test to ensure water is draining correctly. If not satisfied at any stage do not proceed with fitting.

Fitting of Shower Tray is acceptance of quality.

KEY FEATURES

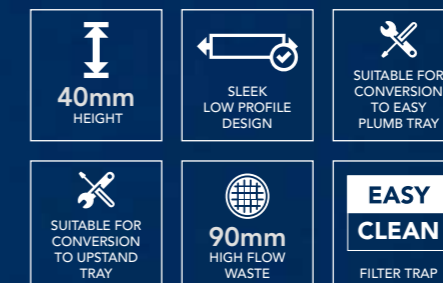

EXCEPTIONAL
EVERYDAY.

SLIMLINE SHOWER TRAYS



Extensive selection of shower tray shapes and sizes to complement your bathroom.

- Strong and rigid construction
- Manufactured to British Standard BS6340/5
- Tough high gloss ABS acrylic capped surface finish
- Easy-to-clean and maintain

SHOWER TRAY INSTALLATION
All shower trays must be installed as per instructions supplied. Please note: Silicone sealants, foams, mastics, installation compound adhesive etc. must not be used as a substitute for cement. Ensure shower tray is installed 100% level and water test to ensure it is draining correctly. Fitting of Shower Tray is acceptance of quality.

40mm
HEIGHT

SLEEK
LOW PROFILE
DESIGN

90mm
HIGH FLOW
WASTE

**EASY
CLEAN**
FILTER TRAP

SUITABLE FOR
CONVERSION
TO EASY
PLUMB TRAY

SLIMLINE RECTANGLE

DESCRIPTION	CODE
800 x 700mm Slimline Rectangle Tray	TSL8070R
900 x 700mm Slimline Rectangle Tray	TSL9070R
900 x 760mm Slimline Rectangle Tray	TSL9076R
900 x 800mm Slimline Rectangle Tray	TSL9080R
1000 x 700mm Slimline Rectangle Tray	TSL10070R
1000 x 760mm Slimline Rectangle Tray	TSL10076R
1000 x 800mm Slimline Rectangle Tray	TSL10080R
1000 x 900mm Slimline Rectangle Tray	TSL10090R
1100 x 700mm Slimline Rectangle Tray	TSL11070R
1100 x 760mm Slimline Rectangle Tray	TSL11076R
1100 x 800mm Slimline Rectangle Tray	TSL11080R
1100 x 900mm Slimline Rectangle Tray	TSL11090R
1200 x 700mm Slimline Rectangle Tray	TSL12070R
1200 x 760mm Slimline Rectangle Tray	TSL12076R
1200 x 800mm Slimline Rectangle Tray	TSL12080R
1200 x 900mm Slimline Rectangle Tray	TSL12090R
1200 x 1000mm Slimline Rectangle Tray	TSL120100R
1300 x 800mm Slimline Rectangle Tray	TSL13080R
1300 x 900mm Slimline Rectangle Tray	TSL13090R
1400 x 700mm Slimline Rectangle Tray	TSL14070R
1400 x 800mm Slimline Rectangle Tray	TSL14080R
1400 x 900mm Slimline Rectangle Tray	TSL14090R
1500 x 700mm Slimline Rectangle Tray	TSL15070R
1500 x 760mm Slimline Rectangle Tray	TSL15076R
1500 x 800mm Slimline Rectangle Tray	TSL15080R
1500 x 900mm Slimline Rectangle Tray	TSL15090R
1600 x 700mm Slimline Rectangle Tray	TSL16070R
1600 x 800mm Slimline Rectangle Tray	TSL16080R
1600 x 900mm Slimline Rectangle Tray	TSL16090R
1700 x 700mm Slimline Rectangle Tray	TSL17070R
1700 x 750mm Slimline Rectangle Tray	TSL17075R
1700 x 800mm Slimline Rectangle Tray	TSL17080R
1700 x 900mm Slimline Rectangle Tray	TSL17090R
1800 x 800mm Slimline Rectangle Tray	TSL18080R
1800 x 900mm Slimline Rectangle Tray	TSL18090R
2000 x 900mm Slimline Rectangle Tray	TSL20090R

SLIMLINE SQUARE

DESCRIPTION	CODE
700 x 700mm Slimline Square Tray	TSL70S
760 x 760mm Slimline Square Tray	TSL76S
800 x 800mm Slimline Square Tray	TSL80S
900 x 900mm Slimline Square Tray	TSL90S
1000 x 1000mm Slimline Square Tray	TSL100S
1200 x 1200mm Slimline Square Tray	TSL120S

SLIMLINE QUADRANT

DESCRIPTION	CODE
800 x 800mm Slimline Quadrant Tray	TSL80Q
900 x 900mm Slimline Quadrant Tray	TSL90Q

SLIMLINE OFFSET QUADRANT

DESCRIPTION	CODE
900 x 760mm Offset Quadrant Tray - Left	TSL9076LOQ
900 x 760mm Offset Quadrant Tray - Right	TSL9076ROQ
900 x 800mm Offset Quadrant Tray - Left	TSL9080LOQ
900 x 800mm Offset Quadrant Tray - Right	TSL9080ROQ
1000 x 800mm Offset Quadrant Tray - Left	TSL10080LOQ
1000 x 800mm Offset Quadrant Tray - Right	TSL10080ROQ
1000 x 900mm Offset Quadrant Tray - Left	TSL10090LOQ
1000 x 900mm Offset Quadrant Tray - Right	TSL10090ROQ
1100 x 800mm Offset Quadrant Tray - Left	TSL11080LOQ
1100 x 800mm Offset Quadrant Tray - Right	TSL11080ROQ
1100 x 900mm Offset Quadrant Tray - Left	TSL11090LOQ
1100 x 900mm Offset Quadrant Tray - Right	TSL11090ROQ
1200 x 800mm Offset Quadrant Tray - Left	TSL12080LOQ
1200 x 800mm Offset Quadrant Tray - Right	TSL12080ROQ
1200 x 900mm Offset Quadrant Tray - Left	TSL12090LOQ
1200 x 900mm Offset Quadrant Tray - Right	TSL12090ROQ

SLIMLINE CORNER SHOWER TRAY WASTES

DESCRIPTION	CODE
800 x 800mm Slimline Quadrant Tray - Corner Waste	CTSL80Q
900 x 900mm Slimline Quadrant Tray - Corner Waste	CTSL90Q
1000 x 1000mm Slimline Quadrant Tray - Corner Waste	CTSL100Q
800 x 800mm Slimline Square Tray - Corner Waste	CTSL80S
900 x 900mm Slimline Square Tray - Corner Waste	CTSL90S
1000 x 1000mm Slimline Square Tray - Corner Waste	CTSL100S
900 x 800mm Slimline Rectangle Tray - Corner Waste	CTSL9080R
1000 x 800mm Slimline Rectangle Tray - Corner Waste	CTSL10080R
1200 x 800mm Slimline Rectangle Tray - Corner Waste	CTSL12080R
1200 x 900mm Slimline Rectangle Tray - Corner Waste	CTSL12090R



SLIMLINE RECTANGLE TRAY INCLUDING SHOWER WASTE



SLIMLINE SQUARE TRAY INCLUDING SHOWER WASTE



SLIMLINE QUADRANT TRAY INCLUDING SHOWER WASTE



SLIMLINE OFFSET QUADRANT TRAY INCLUDING SHOWER WASTE (right hand illustrated)

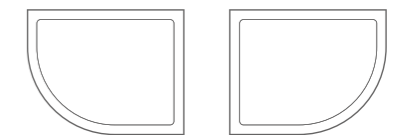

OFFSET QUADRANT LEFT HAND

OFFSET QUADRANT RIGHT HAND

NOTE: It is normal for a small amount of localised water to be retained on a shower tray surface after use. This should be wiped dry to prevent any build up of residue.

ANTI-SLIP SHOWER TRAYS

NOTE: It is normal for a small amount of localised water to be retained on a shower tray surface after use. This should be wiped dry to prevent any build up of residue.

ANTI-SLIP SLIMLINE RECTANGLE

DESCRIPTION	CODE
Anti-Slip Slimline Rectangle Tray 1000 x 800mm	ASTSL10080R
Anti-Slip Slimline Rectangle Tray 1000 x 900mm	ASTSL10090R
Anti-Slip Slimline Rectangle Tray 1100 x 800mm	ASTSL11080R
Anti-Slip Slimline Rectangle Tray 1100 x 900mm	ASTSL11090R
Anti-Slip Slimline Rectangle Tray 1200 x 700mm	ASTSL12070R
Anti-Slip Slimline Rectangle Tray 1200 x 760mm	ASTSL12076R
Anti-Slip Slimline Rectangle Tray 1200 x 800mm	ASTSL12080R
Anti-Slip Slimline Rectangle Tray 1200 x 900mm	ASTSL12090R
Anti-Slip Slimline Rectangle Tray 1400 x 700mm	ASTSL14070R
Anti-Slip Slimline Rectangle Tray 1400 x 800mm	ASTSL14080R
Anti-Slip Slimline Rectangle Tray 1400 x 900mm	ASTSL14090R
Anti-Slip Slimline Rectangle Tray 1500 x 700mm	ASTSL15070R
Anti-Slip Slimline Rectangle Tray 1500 x 800mm	ASTSL15080R
Anti-Slip Slimline Rectangle Tray 1500 x 900mm	ASTSL15090R
Anti-Slip Slimline Rectangle Tray 1600 x 700mm	ASTSL16070R
Anti-Slip Slimline Rectangle Tray 1600 x 800mm	ASTSL16080R
Anti-Slip Slimline Rectangle Tray 1600 x 900mm	ASTSL16090R
Anti-Slip Slimline Rectangle Tray 1700 x 700mm	ASTSL17070R
Anti-Slip Slimline Rectangle Tray 1700 x 800mm	ASTSL17080R
Anti-Slip Slimline Rectangle Tray 1700 x 900mm	ASTSL17090R

- Anti-slip coating for extra safety in the showering space
- Pendulum slip tested, in accordance with British Standard BS7976:2
- Classified as low slip potential



TEXTURED SURFACE OF THE ANTI-SLIP TRAY

SHOWER TRAY INSTALLATION
All shower trays must be installed as per instructions supplied. Please note: Silicone sealants, foams, mastics, installation compound adhesive etc. must not be used as a substitute for cement. Ensure shower tray is installed 100% level and water test to ensure it is draining correctly. Fitting of Shower Tray is acceptance of quality.

ANTI-SLIP SLIMLINE SQUARE

DESCRIPTION	CODE
Anti-Slip Slimline Square Tray 800mm	ASTSL80S
Anti-Slip Slimline Square Tray 900mm	ASTSL90S
Anti-Slip Slimline Square Tray 1000mm	ASTSL100S

ANTI-SLIP SLIMLINE QUADRANT

DESCRIPTION	CODE
Anti-Slip Slimline Quadrant Tray 800mm	ASTSL80Q
Anti-Slip Slimline Quadrant Tray 900mm	ASTSL90Q
Anti-Slip Slimline Quadrant Tray 1000mm	ASTSL100Q

ANTI-SLIP OFFSET QUADRANT

DESCRIPTION	CODE
Anti-Slip Slimline Offset Quadrant Tray 1000 x 800mm - Left	ASTSL10080LOQ
Anti-Slip Slimline Offset Quadrant Tray 1000 x 800mm - Right	ASTSL10080ROQ
Anti-Slip Slimline Offset Quadrant Tray 1000 x 900mm - Left	ASTSL10090LOQ
Anti-Slip Slimline Offset Quadrant Tray 1000 x 900mm - Right	ASTSL10090ROQ
Anti-Slip Slimline Offset Quadrant Tray 1200 x 800mm - Left	ASTSL12080LOQ
Anti-Slip Slimline Offset Quadrant Tray 1200 x 800mm - Right	ASTSL12080ROQ
Anti-Slip Slimline Offset Quadrant Tray 1200 x 900mm - Left	ASTSL12090LOQ
Anti-Slip Slimline Offset Quadrant Tray 1200 x 900mm - Right	ASTSL12090ROQ

ANTI-SLIP SLIMLINE - TRAYS WITH CORNER WASTE

DESCRIPTION	CODE
900 x 900mm Slimline Quadrant Tray - Corner Waste	CASTSL90Q
1000 x 1000mm Slimline Quadrant Tray - Corner Waste	CASTSL100Q
800 x 800mm Slimline Square Tray - Corner Waste	CASTSL80S
1000 x 1000mm Slimline Square Tray - Corner Waste	CASTSL100S
1000 x 800mm Slimline Rectangle Tray - Corner Waste	CASTSL10080R
1200 x 800mm Slimline Rectangle Tray - Corner Waste	CASTSL12080R
1200 x 900mm Slimline Rectangle Tray - Corner Waste	CASTSL12090R



RECTANGLE TRAY CORNER WASTE



SQUARE TRAY CORNER WASTE



900mm QUADRANT TRAY CORNER WASTE



800mm QUADRANT TRAY CORNER WASTE

25MM ULTRA SLIM SHOWER TRAYS

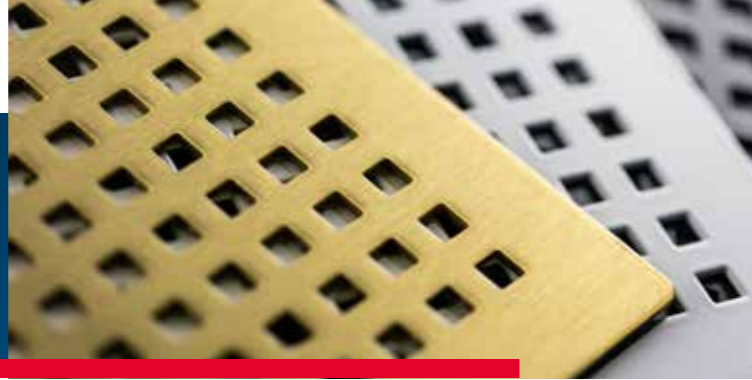

25MM ANTI-SLIP ULTRA SLIM SHOWER TRAYS

RECTANGLE

DESCRIPTION	CODE
Ultra Slim Rectangle Tray 1000 x 800mm - Inc.Waste & White Grill	USLI0080R
Ultra Slim Rectangle Tray 1000 x 900mm - Inc.Waste & White Grill	USLI0090R
Ultra Slim Rectangle Tray 1200 x 800mm - Inc.Waste & White Grill	USLI12080R
Ultra Slim Rectangle Tray 1200 x 900mm - Inc.Waste & White Grill	USLI12090R
Ultra Slim Rectangle Tray 1400 x 800mm - Inc.Waste & White Grill	USLI14080R
Ultra Slim Rectangle Tray 1400 x 900mm - Inc.Waste & White Grill	USLI14090R
Ultra Slim Rectangle Tray 1500 x 800mm - Inc.Waste & White Grill	USLI15080R
Ultra Slim Rectangle Tray 1500 x 900mm - Inc.Waste & White Grill	USLI15090R
Ultra Slim Rectangle Tray 1600 x 800mm - Inc.Waste & White Grill	USLI16080R
Ultra Slim Rectangle Tray 1600 x 900mm - Inc.Waste & White Grill	USLI16090R
Ultra Slim Rectangle Tray 1700 x 800mm - Inc.Waste & White Grill	USLI17080R
Ultra Slim Rectangle Tray 1700 x 900mm - Inc.Waste & White Grill	USLI17090R
Ultra Slim Rectangle Tray 1800 x 800mm - Inc.Waste & White Grill	USLI18080R
Ultra Slim Rectangle Tray 1800 x 900mm - Inc.Waste & White Grill	USLI18090R

SQUARE

DESCRIPTION	CODE
Ultra Slim Square Tray 800 x 800mm - Inc.Waste & White Grill	USL80S
Ultra Slim Square Tray 900 x 900mm - Inc.Waste & White Grill	USL90S
Ultra Slim Square Tray 1000 x 1000mm - Inc.Waste & White Grill	USL100S

QUADRANT & OFFSET QUADRANT

DESCRIPTION	CODE
Ultra Slim Quadrant Tray 800 x 800mm	USL80Q
Ultra Slim Quadrant Tray 900 x 900mm	USL90Q
Ultra Slim Offset Quadrant Tray 1000 x 800mm Left Hand - Inc.Waste & White Grill	USLI0080LOQ
Ultra Slim Offset Quadrant Tray 1000 x 800mm Right Hand - Inc.Waste & White Grill	USLI0080ROQ
Ultra Slim Offset Quadrant Tray 1200 x 800mm Left Hand - Inc.Waste & White Grill	USLI12080LOQ
Ultra Slim Offset Quadrant Tray 1200 x 800mm Right Hand - Inc.Waste & White Grill	USLI12080ROQ
Ultra Slim Offset Quadrant Tray 1200 x 900mm Left Hand - Inc.Waste & White Grill	USLI12090LOQ
Ultra Slim Offset Quadrant Tray 1200 x 900mm Right Hand - Inc.Waste & White Grill	USLI12090ROQ

RECTANGLE

DESCRIPTION	CODE
Anti-Slip Ultra Slim Rectangle Tray 1000 x 800mm - Inc.Waste & White Grill	AUSLI0080R
Anti-Slip Ultra Slim Rectangle Tray 1200 x 800mm - Inc.Waste & White Grill	AUSLI12080R
Anti-Slip Ultra Slim Rectangle Tray 1200 x 900mm - Inc.Waste & White Grill	AUSLI12090R
Anti-Slip Ultra Slim Rectangle Tray 1400 x 800mm - Inc.Waste & White Grill	AUSLI14080R
Anti-Slip Ultra Slim Rectangle Tray 1400 x 900mm - Inc.Waste & White Grill	AUSLI14090R
Anti-Slip Ultra Slim Rectangle Tray 1500 x 800mm - Inc.Waste & White Grill	AUSLI15080R
Anti-Slip Ultra Slim Rectangle Tray 1600 x 800mm - Inc.Waste & White Grill	AUSLI16080R
Anti-Slip Ultra Slim Rectangle Tray 1600 x 900mm - Inc.Waste & White Grill	AUSLI16090R
Anti-Slip Ultra Slim Rectangle Tray 1700 x 800mm - Inc.Waste & White Grill	AUSLI17080R
Anti-Slip Ultra Slim Rectangle Tray 1700 x 900mm - Inc.Waste & White Grill	AUSLI17090R

SQUARE

DESCRIPTION	CODE
Anti-Slip Ultra Slim Square Tray 900 x 900mm - Inc.Waste & White Grill	AUSL90S

ULTRA SLIM TRAY GRILLS

DESCRIPTION	CODE
 Ultra Slim Tray Grill - Brushed Brass	USLTGBB
 Ultra Slim Tray Grill - Matte Black	USLTGMB
 Ultra Slim Tray Grill - Chrome	USLTGTC
 Ultra Slim Tray Grill - White	USLTGW



ULTRA SLIM RECTANGLE TRAY INCLUDING WASTE AND WHITE GRILL



ULTRA SLIM SQUARE TRAY INCLUDING WASTE AND WHITE GRILL



ULTRA SLIM QUADRANT TRAY INCLUDING WASTE AND WHITE GRILL



ULTRA SLIM OFFSET QUADRANT TRAY INCLUDING WASTE AND WHITE GRILL

EASY PLUMB KIT SUITS ALL SLIMLINE SHOWER TRAYS

Slimline easy plumb shower kits have adjustable legs to comply with building regulations to assist in installation and for maintenance of waste outlets if required after building settlement.

The slimline easy plumb kit provides this access without compromising on style in the bathroom.

An easy plumb tray can be made by using any of the Flair slimline trays and a kit. This will increase the height of the tray by 95mm.

Accessories are not to scale - for visual representation only.



DESCRIPTION	WEIGHT	CODE
Easy Plumb Riser Kit For All Square Trays & Rectangle Trays (Suitable for maximum tray size of 1200mm)	2kg	WD3
Easy Plumb Riser Kit For All Quadrant Trays (Suitable for maximum tray size of 1200 x 900mm)	3kg	WD4
Easy Plumb Riser Kit For All Square Trays & Rectangle Trays (Suitable for maximum tray size of 2000mm)	2kg	WD5
Viva Shower Waste	1kg	TSLWASTE



WASTES

MCALPINE WASTES

DESCRIPTION	COLOUR	CODE
McAlpine 90mm Shower Waste with Plastic Dome	White	ST90WH10-70
McAlpine 90mm Shower Waste with Plastic Dome	Matte Black	ST90MB10-70



SHOWER TRAP WASTES

Further enhance the look of your shower tray with our **NEW** 90mm High Flow Shower Waste featuring a modern and stylish finish.

Constructed from brass and plated in the following colours; **Brushed Brass, Brushed Copper, Brushed Nickel, Matte Black and Matte White.**

90MM SLIM TRAY WASTES		
DESCRIPTION	COLOUR	CODE
90mm Slim Tray Waste	Brushed Brass	TSLWASTEBB
90mm Slim Tray Waste	Brushed Copper	TSLWASTEBC
90mm Slim Tray Waste	Brushed Nickel	TSLWASTEBN
90mm Slim Tray Waste	Matte Black	TSLWASTEMB
90mm Slim Tray Waste	White	TSLWASTEMW



PROSEAL WATERPROOF BARRIER SEAL

Flexible up-stand seal installed onto shower trays, baths and worktops eliminating the risk of water leakage.

PROSEAL	
DESCRIPTION	CODE
ProSeal 2 metre Roll	PROS2.0M
ProSeal 2.5 metre Roll	PROS2.5M
ProSeal 3 metre Roll	PROS3.0M
ProSeal 3.5 metre Roll	PROS3.5M
ProSeal 4 metre Roll	PROS4.0M
ProSeal 10 metre Roll	PROS10.0M
ProSeal 20 metre Roll	PROS20.0M

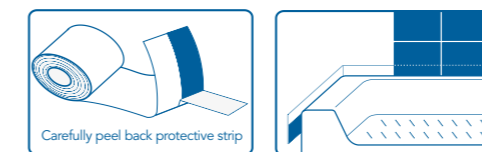

SHOWER TRAY SHAPES

FIND YOUR PERFECT FIT



SQUARE



RECTANGLE



QUADRANT



OFFSET QUADRANT LEFT HAND



OFFSET QUADRANT RIGHT HAND

SHOWER DOOR STYLES

DESIGNED TO FIT YOUR SPACE



SLIDING DOOR



CORNER ENTRY



OFFSET QUADRANT



PIVOT DOOR



QUADRANT



BIFOLD DOOR

AT A GLANCE METRIC CONVERTER

NOMINAL GUIDE ONLY

METRIC (MM)	FEET (FT)	INCHES (INS)
700	2 ft 3.5	27.5
760	2 ft 6.0	30
800	2 ft 7.5	31.5
900	2 ft 11.4	35.5
1000	3 ft 3.5	39.5
1100	3 ft 7.3	43.3
1200	3 ft 11.2	47.2

SHOWER DOOR MEASURING GUIDE

Note: Your measurements should be taken after tray installation and tiling.
The space left after tiling will determine the shower door size required.

FOR A RECESS

Measurement at low point _____

Measurement at high point _____

* Two measures relevant for uneven walls to ensure shower door caters for adjustment width needed

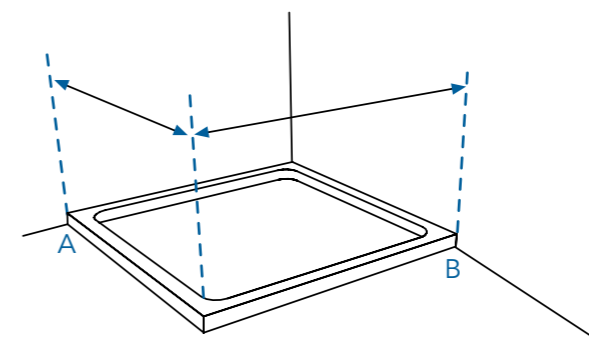
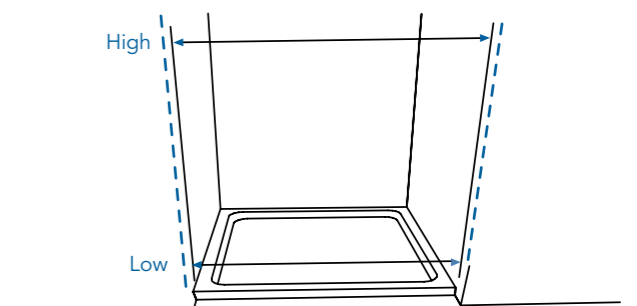

FOR A CORNER

Measure to acute edge of shower tray

Measurement A _____ B _____

FOR A QUADRANT*

Radius Guide	
Distance 'C' (mm)	Radius (mm)
207	500
218	525
228	550

*All Flair Quadrant and Offset Quadrant trays have a 550mm radius.

Timbers placed at right angles to determine C

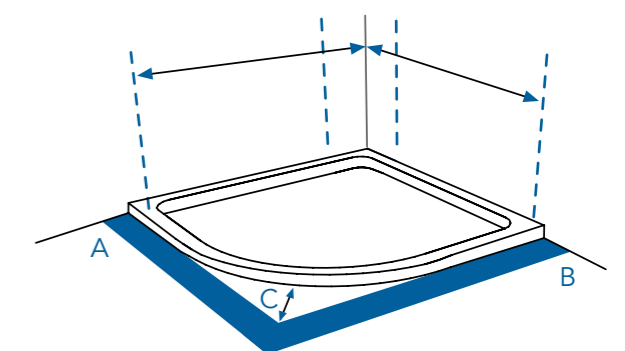

Measurement

A _____ B _____ C _____

QUALITY GUARANTEED

QUALITY GUARANTEED

At Flair we have an unwavering commitment to product quality.

All Flair products are CE approved and manufactured in accordance with ISO 9001:2000 Quality Assurance systems. All glass is toughed safety glass and produced to EN12150. Flair products are performance tested to EN14428, ensuring the highest industry criteria is met.

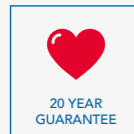

The Flair PRO Essential Collections are covered by a 20 year guarantee against manufacturer defect.

This guarantee is valid on condition that the goods are installed and maintained in accordance with the products fitting instructions and best practices.

Non glass and detachable parts such as rollers, seals etc. are subject to normal wear and tear during usage and are under guarantee for 12 months from time of purchase.

Please complete your product guarantee card included in the components box or register online at flairshowers.com/register.

Note: Proof of purchase is necessary to validate your guarantee so retain purchase receipt for your Flair product.

If a Flair shower enclosure is defective in materials or manufacture, please contact us on 0800 180 8050.

CLEARVUE GLASS TREATMENT SYSTEM

VERVE shower doors, wetroom panels and Bathscreens are supplied with a special glass coating designed to reduce limescale build up and make cleaning the glass easier:

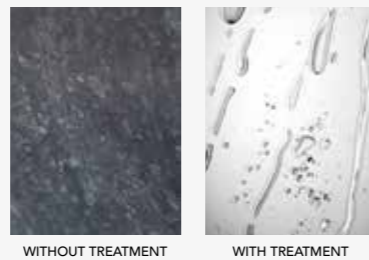

AFTERSALES & SPARE PARTS SERVICE

Flair is 100% committed to customer service excellence.

We carry a full range of spare parts for each product collection and have dedicated aftersales specialists to deal with any issues you may have.

If you have any queries, please contact Flair on 0800 180 8050.

RETURN POLICY

Flair will not accept return of any product that has been opened.

We do not accept return of any product if the packaging has been damaged.

If the product is unopened and not damaged, we will accept the return of the product but a handling fee of 25% of the invoice will be charged.

SHOWER DOOR INSTALLATION ADVICE

BEFORE YOU INSTALL YOUR SHOWER ENCLOSURE PLEASE READ ALL INSTRUCTIONS. FAILURE TO DO SO MAY LEAD TO INVALIDATION OF YOUR GUARANTEE.

Flair Showers Ltd will not accept responsibility for any loss or damage, however caused, if the shower enclosure has not been installed as per the instructions.

- The shower tray MUST be fitted 100% level. The shower tray must be sealed correctly to prevent any water leakage.
- Glass edges are vulnerable and should be treated with care at all times. Contact with hard surfaces may result in glass breakage if due care is not taken.
- Check walls for electrical cabling or water pipes before drilling.
- Your shower enclosure, Bathscreen or wetroom must be inspected before installation. Check for all visual defects on the product before installation. Once the enclosure has been installed no claims of damage or defect will be accepted. Fitting of shower enclosure is acceptance of quality.
- The wall plugs supplied with the shower door are for use in solid walls. Timber frame, stud partition walls will require alternative fixings.
- Ensure vertical wall profiles are level and are an equal distance in from the tray.
- Shower Doors, Wetroom Screens, Bathscreens and Side Panels are adjustable between the dimensions stated. All dimensions are approximate.
- Ensure adjustment at wall profiles are equal at both sides and that all screws are fully tightened.
- Ensure hinges are level and securely fitted to the glass.
- Ensure magnets are the right orientation and are attracting rather than repelling.
- The shower enclosure should be sealed on the outside only using silicone sealant.

- Care must be taken during assembly. Flair will not accept responsibility where incorrect assembly results in undue stress being put on any components in this product.
- If there are any manufacturer defects, please call Flair Service Line on 0800 180 8050.
- Note: If a problem has been caused by incorrect installation, a call-out charge will apply for the Flair technical engineer's time. Subsequent charges will apply "to fix" a problem caused by incorrect installation.

BATHSCREEN INSTALLATION

The Bathscreen must be installed on a 100% level surface with the bath edge free from obstructions.

Bathscreens should not be used on a bath with roll top rim, stepped edge rim or where the bath handle void meets the Bathscreen seal. This will impact on the performance of the bathscreen and the guarantee will be void. The Bathscreen should be fitted to the inside edge of the bath only.

A Bathscreen acts as a water deflector and is not 100% waterproof. If used appropriately under normal showering conditions and installed to the inside edge of the bath, water will be deflected into the showering area. Bathscreens are not suitable for power showers.

SHOWER TRAY INSTALLATION

All shower trays must be installed as per instructions supplied. Install on a base of fine sand, cement and cement additive. Please note: Silicone sealants, foams, mastics, installation compound adhesive or similar must not be used as a substitute for cement. Ensure shower tray is 100% level and water test to ensure water is draining correctly. If not satisfied at any stage do not proceed with fitting. Fitting of Shower Tray is acceptance of quality.

NOTE: It is normal for a small amount of localised water to be retained on a shower tray surface after use. This should be wiped dry to prevent any build up of residue.

CLEANING GUIDELINES

- Glass: Use a soft cloth and mild detergent, rinse off thoroughly.
- Metallic Surfaces: Use a soft cloth and warm soapy water. Rinse off thoroughly.
- Do not use "Spray & leave" cleaning products on the metal surface as these will cause damage to your product. These include acidic based cleaning products, bleaches, solvents or abrasive pads. Only use detergents, cleaners and limescale removers with a pH of 5-8.
- The constant use of detergents will degrade the finish of the product over time if not thoroughly rinsed off.
- In hard water areas, regular cleaning of your Flair door will help to prevent the build-up of limescale. Stubborn deposits of limescale can be removed with the use of a mild limescale remover.
- Check your shower door for functionality periodically. Ensure that the wheel track is free from any grit/dirt which may have collected over time.

CONDITIONS OF SALE

Unless otherwise stated, all quotations are subject to acceptance within 30 days of date of issue.









Other than in the case of faulty goods / incorrect despatch, Flair will not accept the return of any product.

As part of our continuing policy of product improvement, we reserve the right to amend specifications, colours and s without prior notice. Images are for illustrated purposes only. The colours and finishes shown in the catalogue are as accurate as possible within the limits of the printing process. The positioning of all shower heads and shower wastes in the brochure is for illustrative purposes only.

***Errors and Omissions Exempt.**

SPECIFICATION COMPARISON...

A selection of our product features and specifications are summarised below to help you select the right collection for every installation.

	VERVE PRO 8 Page 12	VERVE PRO Page 22	VERVE PRO WETROOMS Page 40	VERVE PRO BATHTHSCREENS Page 44		SLIMLINE TELESCOPIC Page 52	FRAMELESS SIX Page 60
GLASS THICKNESS	Up to 8mm	6mm	8mm	6 + 8mm	GLASS THICKNESS	6mm	6mm
DOOR HEIGHT	1950mm	1900mm	2000mm	Up to 1500mm	DOOR HEIGHT	1950mm	1950mm
FITTING / ASSEMBLY			-	-	FITTING / ASSEMBLY		-
ADJUSTMENT	Up to 50mm	Up to 50mm	Up to 15mm	Up to 15mm	ADJUSTMENT	Up to 100mm	Up to 50mm
FINISHES					FINISHES		
ROLLER WHEELS	Quick Release Double Wheel	Quick Release Double Wheel	Quick Release Double Wheel	Quick Release Double Wheel	ROLLER WHEELS	Quick Release Double Wheel	-
GLASS COATING	Clearvue	Clearvue	Clearvue	Clearvue	GLASS COATING	Clean Easy	Clean Easy
COVER CAPS / STRIPS	Chrome / Black Plated	Chrome / Black Plated	Chrome / Black Plated	Chrome / Black Plated	COVER CAPS / STRIPS	Chrome Plated	Chrome / Black Plated
PVC-CLEAR SEALS	YES	YES	YES	YES	PVC-CLEAR SEALS	YES	YES
SHOWER TRAY COMPATIBLE	YES	YES	YES	YES	SHOWER TRAY COMPATIBLE	YES	YES
WETROOM COMPATIBLE	YES	YES	YES	YES	WETROOM COMPATIBLE	-	YES
GUARANTEE	20 Years	20 Years	20 Years	20 Years	GUARANTEE	20 Years	20 Years





**CLICK FIT
PRO**

**INSTALLERS
CHOICE**



**JOIN OUR EXCLUSIVE
WHATSAPP GROUP**

Stay updated on our latest locations and events.
Get real-time updates and join us when we're in your area.



"We are committed to supporting installers with high-quality products that make their jobs easier and more efficient. Flair PRO is engineered with innovations that simplify installations and is trusted for its reliability and performance. We are proud to be the installer's choice."

Johnny O'Callaghan
SALES DIRECTOR



flair
—

Flair Showers

England / Scotland / Wales
0800 180 8050

sales@flairshowers.co.uk



FLAIRSHOWERS.COM

